

Tables + Accessories for the Government of Canada

Pricing effective January 1, 2025 - Canada

Revised January 10, 2025

E60PQ-14003/071/PQ



PRICE LIST desking + tables



think global

THE GLOBAL EDGE

ERGONOMICS IN THE OFFICE

- Full range of ergonomically designed workplace, healthcare and office furniture with competitive pricing and built-in value.

STRENGTH AND STABILITY

- Established in 1966.
- One of North America's largest office furniture manufacturers.
- Manufacturing and showrooms worldwide.

STRONG LOCAL REPRESENTATION

- Service and expert advice where you are, when you need it!

MANUFACTURING CAPABILITY

- Vertical integration ensures "start to finish" control.
- Ongoing research and investment in new, innovative production technology.

QUALITY ASSURANCE

- The quality program is registered to ISO 9001.
- On-site furniture testing facility.
- Products and components are tested to meet or exceed ANSI/BIFMA standards.
- Products backed by Global's Limited Lifetime Warranty.

ENVIRONMENTAL COMMITMENT

- Continuous development of "earth friendly" programs.
- One of the first molded foam manufacturers to create ozone-friendly, CFC and HFC-free processes.
- Many seat and back pans are made from recyclable plastics and wood waste, enabling little waste and cost effective products.

TABLE OF CONTENTS

WORKPLACE

TABLES - CAFÉ, MEETING & CONFERENCE

Swap	16
Zira boardroom tables	5

TABLES - TRAINING

Bungee	44
Junction.....	56

TABLES - RECEPTION & OCCASIONAL

Citi	64
Cylinder and cube occasional tables	65
River+	67
Sirena	69
Soda	70
Wind.....	71

PRODUCTIVITY SOLUTIONS by Global

Keyboard trays	80
Manual height adjustable tables.....	75
Monitor arms.....	78
Newland height adjustable base.....	92
Newland pedestals.....	93
Office accessories	90
Power/data.....	83
Productivity Solutions	74

REFERENCE

Finishes	94
Terms and Conditions.....	97
Lifetime Warranty	100
Index.....	101

CAFETERIA TABLES

Swap16

CLASSROOM + LAB TABLES

Bungee44

Junction.....56

LOUNGE TABLES

Citi64

Sirena69

Swap16

Wind.....71

MEETING + COLLABORATIVE TABLES

Bungee44

Swap16

Zira5

MOBILE TABLES

Bungee44

Junction.....56

ACCESSORIES

Keyboard mechanisms81

Keyboard trays80

Monitor arms.....78

Office accessories90

Power solutions.....83

tables

café, meeting and conference



Zira

5



Swap

16



TOP AND BASE FINISHES

ACJ Absolute Acajou	FCL First Class
ASN Asian Night	NBL Noce Biondo
AWC Avant Cherry	NGL Noce Grigio
AWH Avant Honey	NEL Noce Leggero
BLK Black	NML Noce Medio
BZD Blizzard	QTM Quartered Mahogany
BRC Brushed Cobalt	SBY Sheer Beauty
CMB Clear Maple	SDT Stonedust
CGY Custom Grey	SOG Storm Grey
DES Dark Espresso	WHE Walnut Heights
DWT Designer White	WHC White Chocolate
FAS Fashionista	WCR Winter Cherry

BASE TRIM FINISHES

BRC Brushed Cobalt
BLK Black

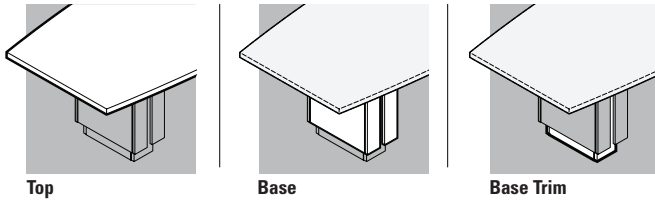

TOP THICKNESS/EDGE DETAIL



C3 1.5" top, standard flat edge

BASES

- 2 doors on base for wire management access from both sides.
- Because of base sizes, custom width less than 96" cannot be accommodated.

TOPS

- 96" tops are standard in one piece. All tops 120", 144" and 168" tops are standard in two equal size pieces. Woodgrain laminate finishes may NOT align where the two tops join. Tops 192" and larger are standard in 3 equal pieces.
- 96" tops are standard with **two bases**.
- Tops 120", 144" and 168" are standard with **three bases**.
- Tops 169" to 288" and larger are standard with **four bases**.
- **Five** top shapes: **boat shaped, bow end, rectangular, racetrack** and **wedge**.

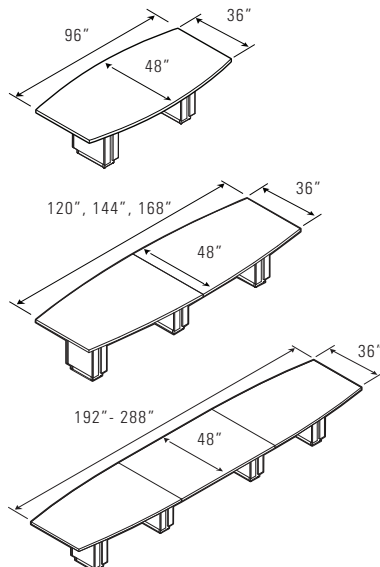

POWER BLOCK OPTIONS AND CUT-OUT LOCATIONS

PRTMCS401B
PRTMCS401T
PRTMCS401W
PRTMCS421B
PRTMCS421T
PRTMCS421W

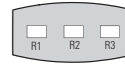

PRTMCD602B
PRTMCD602T
PRTMCD602W
PRTMCD622B
PRTMCD622T
PRTMCD622W
PRTMCD642B
PRTMCD642T
PRTMCD642W

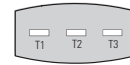

- For **Square, Media** and **Collaborative Tables**, please refer to the electronic Zira Design Guide found on the Global website under Brochures.

CUT-OUTS

- **Boardroom** and **collaborative tables** offer optional cut-outs for in-surface mounted power modules in three standard locations - left, center or right (R1, R2, R3 or T1, T2, T3 as per above grid) for all table shapes excluding square boardroom tables. **Add \$91** for each cut-out.
- Cut-out options for **square boardroom tables** in centered position only - R2 or T2. **Add \$91**.
- Cut-out options for **media tables** in position 1 only - R1 or T1. **Add \$91**.
- Cut-outs may be placed at non-standard locations. Please submit a NON-STANDARD CUT-OUT request form with your order. Forms can be found on the Global Dealer Center under "Specials".
- Available power modules are listed on pages 83-85.
- Be sure to specify matching power module with corresponding cut-out codes (as per above grid). Cut-out size(s) and orientation(s) are specific to the power module(s).
- Refer to **Zira Boardroom Design Guide** online for more information.

Z ZIRA™ BOARDROOM

TABLE NOTES - ESTIMATED CAPACITY

- Use the following to determine the size of a round table and the number of chairs needed for a conference area. All estimates are based on an average chair width of 23" with a 4" clearance between chairs. Adjust accordingly for a different chair size.

Top Size	Rectangular	Bow End	Boat	Racetrack
48 x 96	6-8	6-8	6-8	6-8
48 x 120	8-10	8-10	8-10	8-10
48 x 144	10-12	10-12	10-12	10-12
48 x 168	12-14	12-14	12-14	12-14
48 x 192	14-16	14-16	14-16	14-16
48 x 216	16-18	16-18	16-18	16-18
48 x 240	18-20	18-20	18-20	18-20
48 x 264	20-22	20-22	20-22	20-22
48 x 288	22-24	22-24	22-24	22-24

BOARDROOM TABLES

MODEL # DIMENSIONS WT/LB. CUBIC FT. 1.5" HP TOP

W x D x H (1.5" TOP)

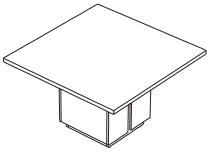

Boardroom Table - Square

Z3636SQ (HP)	36 x 36 x 30	129	10	\$3025
Z4242SQ (HP)	42 x 42 x 30	165.5	13.5	\$3518
Z4848SQ (HP)	48 x 48 x 30	190	14.25	\$3905
Z5454SQ (HP)	54 x 54 x 30	262	21.25	\$4448
Z6060SQ (HP)	60 x 60 x 30	300	22.75	\$4871

Square table includes one base with wire access doors on each side of base. Shipped easy to assemble in 2 cartons.

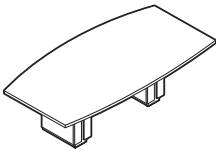

Boardroom Table - Boat Shaped

Z4896BE (HP)	96 x 48 x 30	342	22	\$4513
--------------	--------------	-----	----	---------------

Boat shaped table includes **two bases** with wire access doors on each side of base and wire concealment runners between bases. Shipped easy to assemble in 3 cartons.

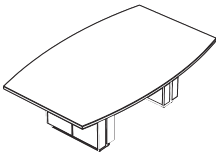

Boardroom Table - Boat Shaped

Z6096BE (HP)	96 x 60 x 30	432	35.5	\$8565
--------------	--------------	-----	------	---------------

Boat shaped table includes two bases with wire access doors on each side of base and wire concealment runners between bases. Shipped easy to assemble in 3 cartons.

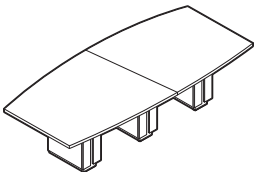

Boardroom Table - Boat Shaped

Z48120BE (HP)	120 x 48 x 30	452	28.3	\$6316
Z48144BE (HP)	144 x 48 x 30	502	30.5	\$6601
Z48168BE (HP)	168 x 48 x 30	557	37.25	\$8365

Boat shaped table includes three bases with wire access doors on each side of base and wire concealment runners between bases. Z48144BE and Z48120BE shipped easy to assemble in 4 cartons. Z48168BE shipped easy to assemble in 5 cartons.

Required specifications

Top finish
Edge detail
Base finish
Base trim finish

Optional specifications

Cut-out for power block

Accessories

Power block

BOARDROOM TABLES **MODEL #** **DIMENSIONS** **WT/LB.** **CUBIC FT.** **1.5" HP TOP**

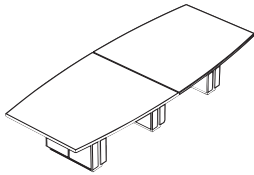

Boardroom Table - Boat Shaped

	W x D x H (1.5" TOP)			
Z60120BE (HP)	120 x 60 x 30	599	48.5	\$12629
Z60144BE (HP)	144 x 60 x 30	664.65	53.25	\$13738
Z60168BE (HP)	168 x 60 x 30	741.3	58	\$14994

Boat shaped table includes three bases with wire access doors on each side of base and wire concealment runners between bases. Shipped easy to assemble in 5 cartons.

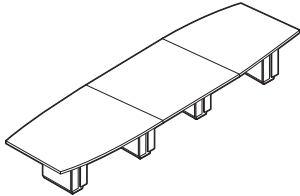

Boardroom Table - Boat Shaped

Z48192BE (HP)	192 x 48 x 30	688	45.75	\$10279
Z48216BE (HP)	216 x 48 x 30	746	48.75	\$10904
Z48240BE (HP)	240 x 48 x 30	803	51.75	\$11692
Z48264BE (HP)	264 x 48 x 30	855	54.75	\$12476
Z48288BE (HP)	288 x 48 x 30	906	57.75	\$12706

Boat shaped table includes four bases with wire access doors on each side of base and wire concealment runners between bases. Shipped easy to assemble in 7 cartons.

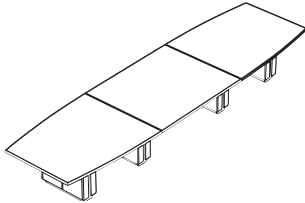

Boardroom Table - Boat Shaped

Z60192BE (HP)	192 x 60 x 30	912.45	71.25	\$18589
Z60216BE (HP)	216 x 60 x 30	980.7	76	\$19815
Z60240BE (HP)	240 x 60 x 30	1062.6	81	\$20878
Z60264BE (HP)	264 x 60 x 30	1129.8	85.75	\$21911
Z60288BE (HP)	288 x 60 x 30	1198.05	90.5	\$23366

Boat shaped table includes four bases with wire access doors on each side of base and wire concealment runners between bases. Shipped easy to assemble in 7 cartons.

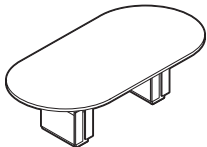

Boardroom Table - Racetrack

Z4896RTE (HP)	96 x 48 x 30	336	22	\$4413
---------------	--------------	-----	----	---------------

Racetrack shaped table includes two bases with wire access doors on each side of base and wire concealment runners between bases. Shipped easy to assemble in 3 cartons.

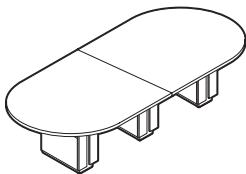

Boardroom Table - Racetrack

Z48120RTE (HP)	120 x 48 x 30	453	28.3	\$6009
Z48144RTE (HP)	144 x 48 x 30	506	30.5	\$6563
Z48168RTE (HP)	168 x 48 x 30	563	37.25	\$8406

Racetrack shaped table includes three bases with wire access doors on each side of base and wire concealment runners between bases. Z48144RTE and Z48120RTE shipped easy to assemble in 4 cartons. Z48168RTE shipped easy to assemble in 5 cartons.

Required specifications

- Top finish
- Edge detail
- Base finish
- Base trim finish

Optional specifications

- Cut-out for power block

Accessories

- Power block

Z ZIRA™ BOARDROOM

BOARDROOM TABLES

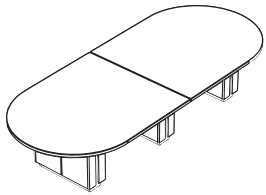

Boardroom Table - Racetrack

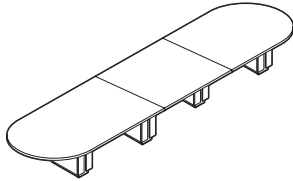

Boardroom Table - Racetrack

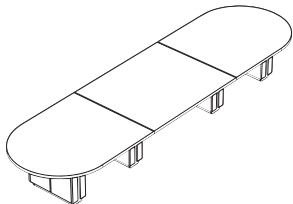

Boardroom Table - Racetrack

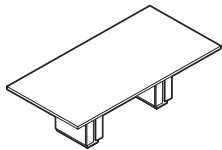

Boardroom Table - Rectangular

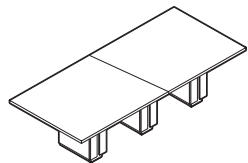

Boardroom Table - Rectangular

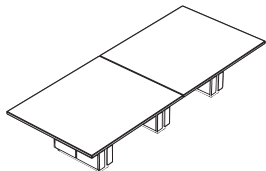

Boardroom Table - Rectangular

MODEL #	DIMENSIONS	WT/LB.	CUBIC FT.	1.5" HP TOP
---------	------------	--------	-----------	-------------

W x D x H (1.5" TOP)

Z60120RTE (HP)	120 x 60 x 30	585.9	48.5	\$12629
Z60144RTE (HP)	144 x 60 x 30	656.25	53.25	\$13738
Z60168RTE (HP)	168 x 60 x 30	737.1	58	\$14994

Racetrack shaped table includes three bases with wire access doors on each side of base and wire concealment runners between bases. Shipped easy to assemble in 5 cartons.

Z48192RTE (HP)	192 x 48 x 30	689	45.75	\$10318
Z48216RTE (HP)	216 x 48 x 30	749	48.75	\$10945
Z48240RTE (HP)	240 x 48 x 30	809	51.75	\$11732
Z48264RTE (HP)	264 x 48 x 30	862	54.75	\$12518
Z48288RTE (HP)	288 x 48 x 30	917	57.75	\$12748

Racetrack shaped table includes four bases with wire access doors on each side of base and wire concealment runners between bases. Shipped easy to assemble in 7 cartons.

Z60192RTE (HP)	192 x 60 x 30	901.95	71.25	\$18589
Z60216RTE (HP)	216 x 60 x 30	972.3	76	\$19815
Z60240RTE (HP)	240 x 60 x 30	1057.35	81	\$20878
Z60264RTE (HP)	264 x 60 x 30	1127.7	85.75	\$21911
Z60288RTE (HP)	288 x 60 x 30	1198.05	90.5	\$23366

Racetrack shaped table includes four bases with wire access doors on each side of base and wire concealment runners between bases. Shipped easy to assemble in 7 cartons.

Z4896REE (HP)	96 x 48 x 30	356	22	\$4497
---------------	--------------	-----	----	---------------

Rectangular shaped table includes two bases with wire access doors on each side of base and wire concealment runners between bases. Shipped easy to assemble in 3 cartons.

Z48120REE (HP)	120 x 48 x 30	472	28.3	\$5994
Z48144REE (HP)	144 x 48 x 30	525	30.5	\$6571
Z48168REE (HP)	168 x 48 x 30	583	37.25	\$8305

Rectangular shaped table includes three bases with wire access doors on each side of base and wire concealment runners between bases. Z48144REE and Z48120REE shipped easy to assemble in 4 cartons. Z48168REE shipped easy to assemble in 5 cartons.

Z60120REE (HP)	120 x 60 x 30	618	48.5	\$11712
Z60144REE (HP)	144 x 60 x 30	688	53.25	\$12759
Z60168REE (HP)	168 x 60 x 30	769	58	\$13928

Rectangular shaped table includes three bases with wire access doors on each side of base and wire concealment runners between bases. Shipped easy to assemble in 5 cartons.

Required specifications

Top finish
Edge detail
Base finish
Base trim finish

Optional specifications

Cut-out for power block

Accessories

Power block

BOARDROOM TABLES **MODEL #** **DIMENSIONS** **WT/LB.** **CUBIC FT.** **1.5" HP TOP**

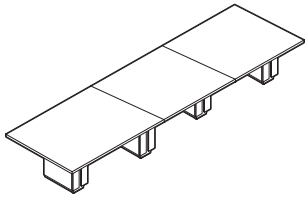

Boardroom Table - Rectangular

	W x D x H (1.5" TOP)			
Z48192REE (HP)	192 x 48 x 30	708	45.75	\$10221
Z48216REE (HP)	216 x 48 x 30	768	48.75	\$10845
Z48240REE (HP)	240 x 48 x 30	828	51.75	\$11632
Z48264REE (HP)	264 x 48 x 30	882	54.75	\$12418
Z48288REE (HP)	288 x 48 x 30	936	57.75	\$12648

Rectangular shaped table includes four bases with wire access doors on each side of base and wire concealment runners between bases. Shipped easy to assemble in 7 cartons.

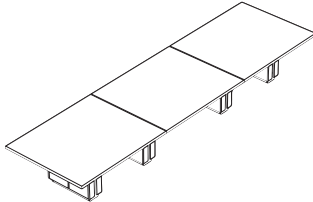

Boardroom Table - Rectangular

Z60192REE (HP)	192 x 60 x 30	941.85	71.25	\$12648
Z60216REE (HP)	216 x 60 x 30	1003.8	76	\$18415
Z60240REE (HP)	240 x 60 x 30	1088.85	81	\$19414
Z60264REE (HP)	264 x 60 x 30	1159.2	85.75	\$20382
Z60288REE (HP)	288 x 60 x 30	1229.55	90.5	\$21730

Rectangular shaped table includes four bases with wire access doors on each side of base and wire concealment runners between bases. Shipped easy to assemble in 7 cartons.

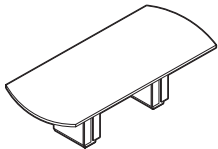

Boardroom Table - Bow End

Z4896BW (HP)	96 x 48 x 30	329	22	\$4623
--------------	--------------	-----	----	---------------

Bow end table includes two bases with wire access doors on each side of base and wire concealment runners between bases. Shipped easy to assemble in 3 cartons.

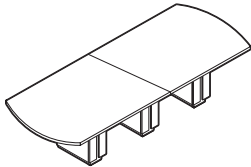

Boardroom Table - Bow End

Z48120BW (HP)	120 x 48 x 30	476	28.3	\$6084
Z48144BW (HP)	144 x 48 x 30	513	30.5	\$6664
Z48168BW (HP)	168 x 48 x 30	573	37.25	\$8336

Bow end table includes three bases with wire access doors on each side of base and wire concealment runners between bases. Z48144BW and Z48120BW shipped easy to assemble in 4 cartons. Z48168BW shipped easy to assemble in 5 cartons.

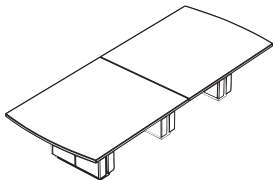

Boardroom Table - Bow End

Z60120BW (HP)	120 x 60 x 30	602	48.5	\$12629
Z60144BW (HP)	144 x 60 x 30	673	53.25	\$13738
Z60168BW (HP)	168 x 60 x 30	753	58	\$14994

Bow end table includes three bases with wire access doors on each side of base and wire concealment runners between bases. Shipped easy to assemble in 5 cartons.

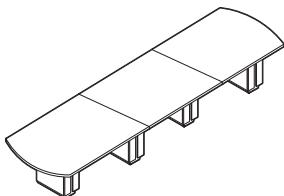

Boardroom Table - Bow End

Z48192BW (HP)	192 x 48 x 30	698	45.75	\$10250
Z48216BW (HP)	216 x 48 x 30	758	48.75	\$10875
Z48240BW (HP)	240 x 48 x 30	818	51.75	\$11662
Z48264BW (HP)	264 x 48 x 30	872	54.75	\$12448
Z48288BW (HP)	288 x 48 x 30	926	57.75	\$12678

Bow end table includes four bases with wire access doors on each side of base and wire concealment runners between bases. Shipped easy to assemble in 7 cartons.

Required specifications

- Top finish
- Edge detail
- Base finish
- Base trim finish

Optional specifications

- Cut-out for power block

Accessories

- Power block

Z ZIRA™ BOARDROOM

BOARDROOM TABLES

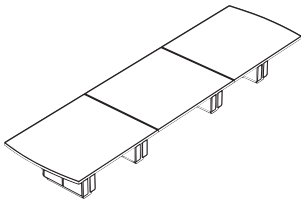

Boardroom Table - Bow End

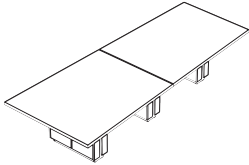

Boardroom Table - Wedge

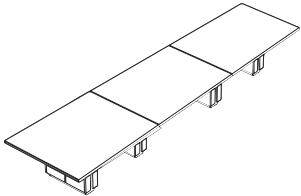

Boardroom Table - Wedge

MODEL #	DIMENSIONS	WT/LB.	CUBIC FT.	1.5" HP TOP
---------	------------	--------	-----------	-------------

W x D x H (1.5" TOP)

Z60192BW (HP)	192 x 60 x 30	917.7	71.25	\$18589
Z60216BW (HP)	216 x 60 x 30	988.05	76	\$19815
Z60240BW (HP)	240 x 60 x 30	1073.1	81	\$20878
Z60264BW (HP)	264 x 60 x 30	1143.45	85.75	\$21911
Z60288BW (HP)	288 x 60 x 30	1213.8	90.5	\$23366

Bow end table includes four bases with wire access doors on each side of base and wire concealment runners between bases. Shipped easy to assemble in 7 cartons.

Z60120WE (HP)	120 x 60 x 30	544.95	36.5	\$12629
Z60144WE (HP)	144 x 60 x 30	603.75	39.5	\$13738
Z60168WE (HP)	168 x 60 x 30	673.05	42.5	\$14994

Wedge table includes three bases with wire access doors on each side of base and wire concealment runners between bases. Wedge tapers from 60"W to 48"W. Shipped easy to assemble in 5 cartons.

Z60192WE (HP)	192 x 60 x 30	824.25	63.75	\$18589
Z60216WE (HP)	216 x 60 x 30	884.1	68.25	\$19815
Z60240WE (HP)	240 x 60 x 30	948.15	73	\$20878
Z60264WE (HP)	264 x 60 x 30	1006.95	77.5	\$21911
Z60288WE (HP)	288 x 60 x 30	1065.75	82	\$23366

Wedge table includes four bases with wire access doors on each side of base and wire concealment runners between bases. Wedge tapers from 60"W to 48"W. Shipped easy to assemble in 7 cartons.

MEDIA TABLES

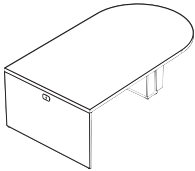

Media Table - D Island

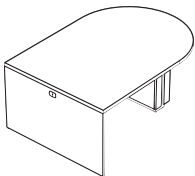

Media Table - D Island

Z4860DMIL (HP)	60 x 48 x 30	267	17.75	\$5178
Z4872DMIL (HP)	72 x 48 x 30	298.2	19.75	\$5634
Z4884DMIL (HP)	84 x 48 x 30	326.55	21.5	\$6080
Z4896DMIL (HP)	96 x 48 x 30	347.55	23.5	\$6523

D media island table includes one base with wire access doors on each side of base and wire concealment runners between the base and the end panel. Grommet centered at the top of the end panel for wire pass through. Shipped easy to assemble in 3 cartons.

Z6060DMIL (HP)	60 x 60 x 30	323.92	23.25	\$6240
Z6072DMIL (HP)	72 x 60 x 30	359.1	25.75	\$6787
Z6084DMIL (HP)	84 x 60 x 30	397.95	28	\$7351
Z6096DMIL (HP)	96 x 60 x 30	433.65	30.5	\$7880

D media island table includes one base with wire access doors on each side of base and wire concealment runners between the base and the end panel. Grommet centered at the top of the end panel for wire pass through. Shipped easy to assemble in 3 cartons.

Required specifications

Top finish
Edge detail
Base finish
Base trim finish

Optional specifications

Cut-out for power block

Accessories

Power block

BOARDROOM TABLES **MODEL #** **DIMENSIONS** **WT/LB.** **CUBIC FT.** **1.5" HP TOP**

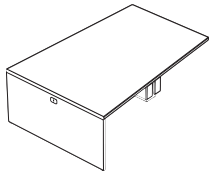

Media Table - Wedge

W x D x H (1.5" TOP)

Z6060WMIL (HP)	60 x 60 x 30	306.6	20.75	\$6240
Z6072WMIL (HP)	72 x 60 x 30	338.1	23	\$6787
Z6084WMIL (HP)	84 x 60 x 30	374.85	25.5	\$7351
Z6096WMIL (HP)	96 x 60 x 30	407.4	28	\$7880

Wedge media island table includes one base with wire access doors on each side of base and wire concealment runners between the base and the end panel. Grommet centered at the top of the end panel for wire pass through. Wedge tapers from 60"W to 48"W. Shipped easy to assemble in 3 cartons.

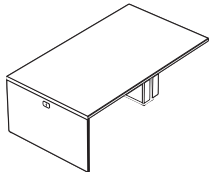

Media Table - Rectangular Island

Z4860RMIL (HP)	60 x 48 x 30	279.3	17.75	\$4818
Z4872RMIL (HP)	72 x 48 x 30	307.65	19.75	\$5250
Z4884RMIL (HP)	84 x 48 x 30	337.05	21.5	\$5664
Z4896RMIL (HP)	96 x 48 x 30	357	23.5	\$6082

Rectangular media island table includes one base with wire access doors on each side of base and wire concealment runners between the base and the end panel. Grommet centered at the top of the end panel for wire pass through. Shipped easy to assemble in 3 cartons.

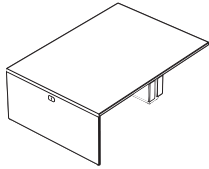

Media Table - Rectangular Island

Z6060RMIL (HP)	60 x 60 x 30	339.15	23.25	\$5803
Z6072RMIL (HP)	72 x 60 x 30	373.8	25.75	\$6317
Z6084RMIL (HP)	84 x 60 x 30	414.75	28	\$6843
Z6096RMIL (HP)	96 x 60 x 30	449.4	30.5	\$7339

Rectangular media island table includes one base with wire access doors on each side of base and wire concealment runners between the base and the end panel. Grommet centered at the top of the end panel for wire pass through. Shipped easy to assemble in 3 cartons.

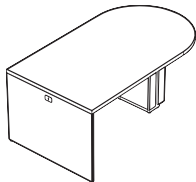

Media Table - D Island, 36.5"H

Z4860DMIM (HP)	60 x 48 x 36.5	291.9	19.25	\$5590
Z4872DMIM (HP)	72 x 48 x 36.5	321.3	21.25	\$6053
Z4884DMIM (HP)	84 x 48 x 36.5	349.65	23	\$6499
Z4896DMIM (HP)	96 x 48 x 36.5	370.65	25	\$6939

D media island table includes one base with wire access doors on each side of base and wire concealment runners between the base and the end panel. Grommet centered at the top of the end panel for wire pass through. Shipped easy to assemble in 3 cartons.

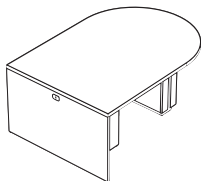

Media Table - D Island, 36.5"H

Z6060DMIM (HP)	60 x 60 x 36.5	352.27	25.5	\$6654
Z6072DMIM (HP)	72 x 60 x 36.5	386.4	27.75	\$7201
Z6084DMIM (HP)	84 x 60 x 36.5	426.3	30.25	\$7765
Z6096DMIM (HP)	96 x 60 x 36.5	462	32.75	\$8291

D media island table includes one base with wire access doors on each side of base and wire concealment runners between the base and the end panel. Grommet centered at the top of the end panel for wire pass through. Shipped easy to assemble in 3 cartons.

Required specifications

- Top finish
- Edge detail
- Base finish
- Base trim finish

Optional specifications

- Cut-out for power block

Accessories

- Power block

Z ZIRA™ BOARDROOM

MEDIA TABLES	MODEL #	DIMENSIONS	WT/LB.	CUBIC FT.	1.5" HP TOP
--------------	---------	------------	--------	-----------	-------------

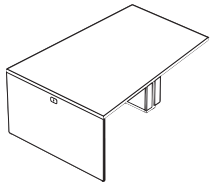

Media Table - Wedge, 36.5"H

	W x D x H (1.5" TOP)			
Z6060WMIM (HP)	60 x 60 x 36.5	331.8	22.25	\$6654
Z6072WMIM (HP)	72 x 60 x 36.5	364.35	24.75	\$7201
Z6084WMIM (HP)	84 x 60 x 36.5	424.2	27	\$7765
Z6096WMIM (HP)	96 x 60 x 36.5	432.6	29.5	\$8291

Wedge media island table includes one base with wire access doors on each side of base and wire concealment runners between the base and the end panel. Grommet centered at the top of the end panel for wire pass through. Wedge tapers from 60"W to 48"W. Shipped easy to assemble in 3 cartons.

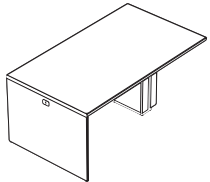

Media Table - Rectangular Island, 36.5"H

Z4860RMIM (HP)	60 x 48 x 36.5	301.35	19.25	\$5195
Z4872RMIM (HP)	72 x 48 x 36.5	330.75	21.25	\$5628
Z4884RMIM (HP)	84 x 48 x 36.5	360.15	23	\$6044
Z4896RMIM (HP)	96 x 48 x 36.5	380.1	25	\$6460

Rectangular media island table includes one base with wire access doors on each side of base and wire concealment runners between the base and the end panel. Grommet centered at the top of the end panel for wire pass through. Shipped easy to assemble in 3 cartons.

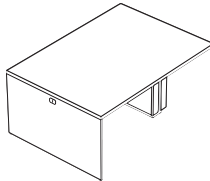

Media Table - Rectangular Island, 36.5"H

Z6060RMIM (HP)	60 x 60 x 36.5	367.5	25.5	\$6177
Z6072RMIM (HP)	72 x 60 x 36.5	402.15	27.75	\$6689
Z6084RMIM (HP)	84 x 60 x 36.5	442.05	30.25	\$7216
Z6096RMIM (HP)	96 x 60 x 36.5	477.75	32.75	\$7711

Rectangular media island table includes one base with wire access doors on each side of base and wire concealment runners between the base and the end panel. Grommet centered at the top of the end panel for wire pass through. Shipped easy to assemble in 3 cartons.

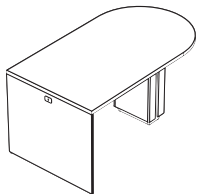

Media Table - D Island, 42.5"H

Z4860DMIH (HP)	60 x 48 x 42.5	312.9	20.75	\$5904
Z4872DMIH (HP)	72 x 48 x 42.5	342.3	22.75	\$6367
Z4884DMIH (HP)	84 x 48 x 42.5	371.7	24.5	\$6812
Z4896DMIH (HP)	96 x 48 x 42.5	391.65	26.5	\$7252

D media island table includes one base with wire access doors on each side of base and wire concealment runners between the base and the end panel. Grommet centered at the top of the end panel for wire pass through. Shipped easy to assemble in 3 cartons.

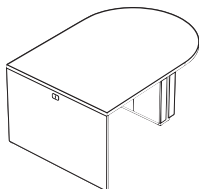

Media Table - D Island, 42.5"H

Z6060DMIH (HP)	60 x 60 x 42.5	378	27.5	\$6968
Z6072DMIH (HP)	72 x 60 x 42.5	413.7	30	\$7514
Z6084DMIH (HP)	84 x 60 x 42.5	453.6	32.5	\$8078
Z6096DMIH (HP)	96 x 60 x 42.5	488.25	35	\$8606

D media island table includes one base with wire access doors on each side of base and wire concealment runners between the base and the end panel. Grommet centered at the top of the end panel for wire pass through. Shipped easy to assemble in 3 cartons.

Required specifications

Top finish
Edge detail
Base finish
Base trim finish

Optional specifications

Cut-out for power block

Accessories

Power block

MEDIA TABLES **MODEL #** **DIMENSIONS** **WT/LB.** **CUBIC FT.** **1.5" HP TOP**

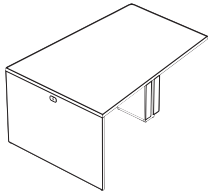

Media Table - Wedge, 42.5"H

	W x D x H (1.5" TOP)				
Z6060WMIH (HP)	60 x 60 x 42.5		355	24	\$6968
Z6072WMIH (HP)	72 x 60 x 42.5		387	26.25	\$7514
Z6084WMIH (HP)	84 x 60 x 42.5		424	28.75	\$8078
Z6096WMIH (HP)	96 x 60 x 42.5		457	31.25	\$8606

Wedge media island table includes one base with wire access doors on each side of base and wire concealment runners between the base and the end panel. Grommet centered at the top of the end panel for wire pass through. Wedge tapers from 60"W to 48"W. Shipped easy to assemble in 3 cartons.

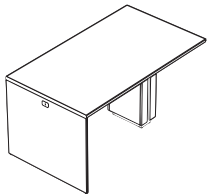

Media Table - Rectangular Island, 42.5"H

Z4860RMIH (HP)	60 x 48 x 42.5		324	20.75	\$5480
Z4872RMIH (HP)	72 x 48 x 42.5		353	22.75	\$5912
Z4884RMIH (HP)	84 x 48 x 42.5		382	24.5	\$6329
Z4896RMIH (HP)	96 x 48 x 42.5		402	26.5	\$6747

Rectangular media island table includes one base with wire access doors on each side of base and wire concealment runners between the base and the end panel. Grommet centered at the top of the end panel for wire pass through. Shipped easy to assemble in 3 cartons.

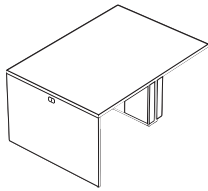

Media Table - Rectangular Island, 42.5"H

Z6060RMIH (HP)	60 x 60 x 42.5		394	27.5	\$6462
Z6072RMIH (HP)	72 x 60 x 42.5		429	30	\$6974
Z6084RMIH (HP)	84 x 60 x 42.5		469	32.5	\$7501
Z6096RMIH (HP)	96 x 60 x 42.5		504	35	\$7997

Rectangular media island table includes one base with wire access doors on each side of base and wire concealment runners between the base and the end panel. Grommet centered at the top of the end panel for wire pass through. Shipped easy to assemble in 3 cartons.

METAL BASE COVERS FOR MEDIA TABLES **LIST PRICE**

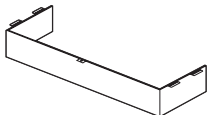

Metal Base Cover for Media Tables

Z48BEC	22.5 x 12.2 x 4.3	5	1.5	\$513
Z60BEC	34.5 x 12.2 x 4.3	6	2	\$561

For use on Zira media tables. Can also be used on any Zira boardroom table of corresponding width. Acts as a cap at the upper part of a base to hide any wire or power block that may be visible to users. Available in Black or Silver finish. Shipped easy to assemble in 1 carton.

COLLABORATIVE TABLES

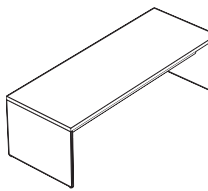

Collaborative Table, 30"H

	W x D x H (1.5" TOP)				
Z367229BT (HP)	72 x 36 x 30		237	13	\$2834
Z368429BT (HP)	84 x 36 x 30		263	14.75	\$3302
Z369629BT (HP)	96 x 36 x 30		289	16.5	\$3613

Collaborative table with full end panels. Wire management runners span the length of the table between end panels. Shipped easy to assemble in 3 cartons.

Required specifications	Optional specifications	Accessories
Top finish Edge detail Base finish Base trim finish	Cut-out for power block	Power block

Z ZIRA™ BOARDROOM

COLLABORATIVE TABLES

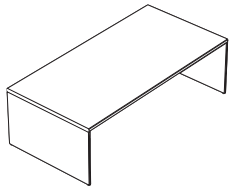

Collaborative Table, 30" H

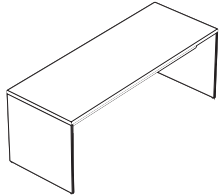

Collaborative Table, 36.5" H

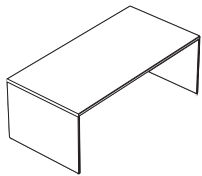

Collaborative Table, 36.5" H

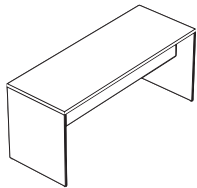

Collaborative Table, 42.5" H

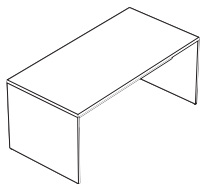

Collaborative Table, 42.5" H

MODEL #	DIMENSIONS	WT/LB.	CUBIC FT.	1.5" HP TOP
---------	------------	--------	-----------	-------------

W x D x H (1.5" TOP)

Z487229BT (HP)	72 x 48 x 30	302	14	\$3604
Z488429BT (HP)	84 x 48 x 30	335	15.75	\$3954
Z489629BT (HP)	96 x 48 x 30	360	17.5	\$4342

Collaborative table with full end panels. Wire management runners span the length of the table between end panels. Shipped easy to assemble in 3 cartons.

Z367236BT (HP)	72 x 36 x 36.5	249	13.25	\$2914
Z368436BT (HP)	84 x 36 x 36.5	275	15	\$3383
Z369636BT (HP)	96 x 36 x 36.5	301	16.75	\$3702

Collaborative table with full end panels. Wire management runners span the length of the table between end panels. Shipped easy to assemble in 3 cartons.

Z487236BT (HP)	72 x 48 x 36.5	319	14.5	\$3714
Z488436BT (HP)	84 x 48 x 36.5	351	16.25	\$4064
Z489636BT (HP)	96 x 48 x 36.5	376	18	\$4453

Collaborative table with full end panels. Wire management runners span the length of the table between end panels. Shipped easy to assemble in 3 cartons.

Z367242BT (HP)	72 x 36 x 42.5	283	14.25	\$3187
Z368442BT (HP)	84 x 36 x 42.5	312	16	\$3686
Z369642BT (HP)	96 x 36 x 42.5	342	18	\$4034

Collaborative table with full end panels. Wire management runners span the length of the table between end panels. Shipped easy to assemble in 3 cartons.

Z487242BT (HP)	72 x 48 x 42.5	356	15.5	\$4010
Z488442BT (HP)	84 x 48 x 42.5	392	17.5	\$4392
Z489642BT (HP)	96 x 48 x 42.5	421	19.25	\$4807

Collaborative table with full end panels. Wire management runners span the length of the table between end panels. Shipped easy to assemble in 3 cartons.

Required specifications

Top finish
Edge detail
Base finish
Base trim finish

Optional specifications

Cut-out for power block

Accessories

Power block

ACCESSORIES **MODEL #** **DIMENSIONS** **WT/LB.** **CUBIC FT.** **LIST PRICE** **HP ADD**

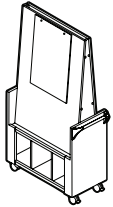

Visual Board*

	W x D x H					
Z361872VB	36 x 18 x 72.4	187	26.5	\$2698	N/A	

Angled visual board with paper pad on one side and dry erase board on the opposite side. Unique push handles are standard. Locking casters included. Decorative aluminum trim is standard on the lip of each shelf. Height aligns with 36" buffets. Shipped easy to assemble in 2 cartons.

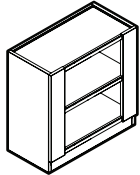

Buffet

Z481829BO	48 x 18 x 29	135	18	\$1514	\$234	
Z361829BO	36 x 18 x 29	112	14	\$1244	\$174	

Buffet features one fixed height adjustable shelf. Top is recessed within side and end panels to act as a tray. Decorative aluminum trim is standard on the lip of each shelf. Shipped assembled in 1 carton.

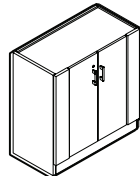

Buffet with Doors**

Z481829BD	48 x 18 x 29	148	18	\$1524	\$234	
Z361829BD	36 x 18 x 29	119	14	\$1278	\$174	

Buffet features two doors with lock and one fixed height adjustable shelf. Top is recessed within side and end panels to act as a tray. Shipped assembled in 1 carton.

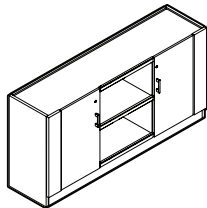

Buffet with Doors**

Z721829BU	72 x 18 x 29	211	27	\$2283	\$351	
Z601829BU	60 x 18 x 29	163	22.5	\$2079	\$293	

Buffet features three separate compartments. The two outer compartments come standard with locking doors and each features one fixed height adjustable shelf. The center compartment is open with one fixed height adjustable shelf. Decorative aluminum trim is standard on the lip of the open shelf. Top is recessed within side and end panels to act as a tray. Shipped assembled in 1 carton.

Required specifications
 Top finish (not Z361872VB)
 Base finish
 Base trim finish
 Push bar finish* Handles**

Optional specifications
 HP laminate

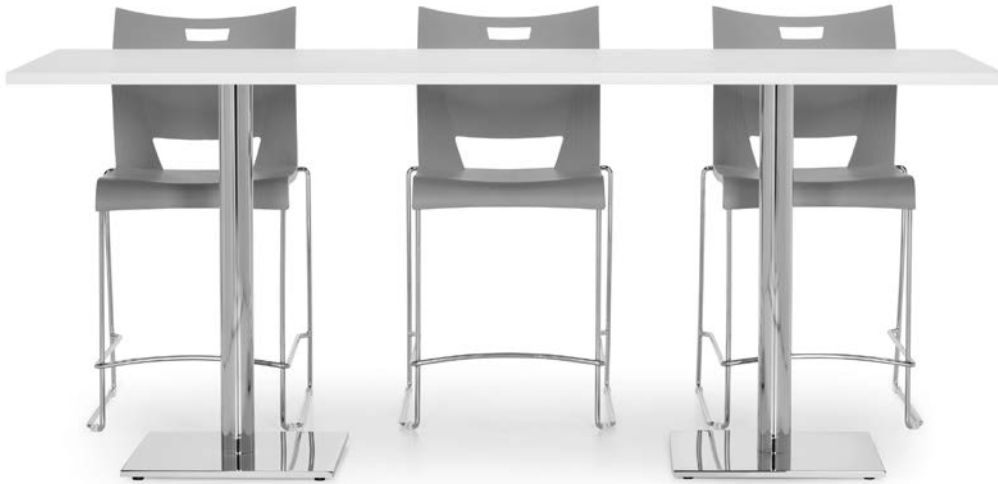

Global's Swap collection is a comprehensive offering including laptop tables, casual meeting tables, café tables, huddle tables and more. Suitable for a variety of applications: break rooms, dedicated/enclosed meeting rooms, casual/open area meeting spaces (lounges, seated, counter and bar height options), and private office (accommodate smaller 3-4 person discussions). Tops and bases are sold separately for ease of specification. Mix and match capabilities to create spaces for multi-purpose use. Choose your top, choose your base. Create the combination you desire for the way you want to work.

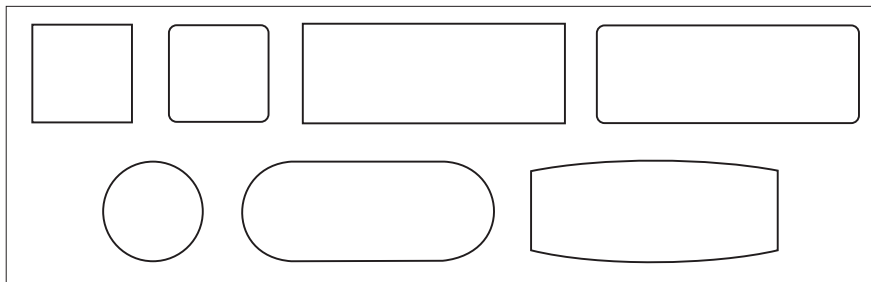

Top shapes

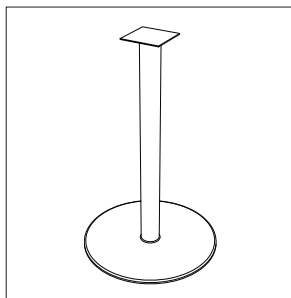

Round base

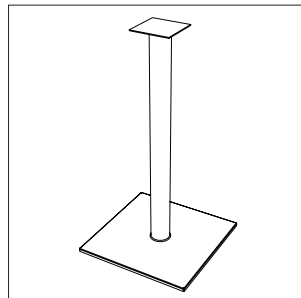

Square base

Features and Benefits

- Tops are available in four materials to help perfect your interior design: high pressure laminate, veneer and solid surface.
- **High pressure laminate** tops are 1 1/16" thick with 2mm flat edge or 1 3/16" thick with knife edge profile. Tops with flat edge have a 45 lb. density particle board core; tops with knife edge have a MDF core.
- **Veneer** tops are 1 3/16" thick overall with matching flat edge or knife edge.
- **Solid surface** tops are 1 1/4" thick with a plywood or particle board melamine subtop depending on size, available with flat edge or knife edge.
- Bases are constructed of a solid steel metal plate and cover - round or square.
- Power block cut-outs are available on most tables.
- 6 heights:
 Coffee table height at 16"H.
 End table height at 22"H.
 Lounge height at 27"H.
 Seated height at 29"H.
 Counter height at 36"H.
 Bar height at 41.5"H.

GENERAL INFORMATION

- Swap is a series of tables for use in casual meeting spaces, lounges, café areas and more.
- The right proportions, flawless surfaces and a solid foundation is sure to become your favorite table series to spec.
- Finish palette coordinates with most Global laminate and veneer casegoods series as well as a variety of solid surface options to choose from - tables can stand-alone or blend with other solutions.
- Each component is packed individually. Bases are shipped assembled, 1 per carton. Easy to assemble.
- For environmental certifications, please visit globalfurnituregroup.com.

WORKSURFACES

- High pressure laminate, veneer and solid surface.
- **High pressure laminate** tops are 1 1/16" thick with 2mm flat edge or 1 3/16" thick with knife edge. 1 1/16" thick tops have a 45 lb. density particle board core and the 2mm flat edge finish can be specified to match or complement the top surface. 1 3/16" thick tops have an MDF core and the knife edge finish will match top surface. Models ending in **(LK)** indicate high pressure laminate with knife edge.
- **Veneer** tops are 1 3/16" thick overall with choice of edge detail - flat edge or knife edge. Edge finish will correspond to surface finish. When flat edge, core material is 45 lb. density particle board; when knife edge, core material is MDF. Models ending in **(V)** indicate veneer.
- **Solid surface** tops are 1 1/4" thick overall with choice of edge detail - flat edge or knife edge. Solid surface material is 0.5" thick with built up edge profile over a particle board or plywood subtop depending on overall top size. Models ending in **(SF)** indicate solid surface with flat edge; models ending in **(SK)** indicate solid surface with knife edge.
- Please see model # for pricing and availability of various material and edge options.
- Refer to page 18 or globalfurnituregroup.com for available finish options.
- While not all sizes are available in all materials:
 - Worksurfaces of 96" or less in length are standard in one piece (1 carton).
 - Worksurfaces 120" to 144" in length are standard in two pieces (2 cartons).
 - Worksurfaces 96", 120" and 144" x 48" include support channels.

BASES

- **Caution:** to meet BIFMA standards for performance and stability, appropriate base size must be specified with corresponding top sizes identified. **Top plates and base plates vary by base size and will only work with table shape sizes as referenced on the following pages.**
- Bases are constructed of a round or square solid steel metal plate for counter balance, covered with a finished steel shroud, affixed with four bolts to a cold rolled steel tube.
- GRB14H25 attaches to tops with a 6" x 6" steel plate, welded to a 1.5" diameter steel tube, bolted to a 0.5" thick solid steel counter balance. Not to be used on tops greater than 22" x 22" in size.
- GSB13H25 and GSOB13H25 attach to tops with a 6" x 6" steel plate, welded to a 1.5" diameter steel tube, bolted to a 0.5" thick solid steel counter balance. Not to be used on tops greater than 22" x 22" in size.
- GRB22H15, GRB22H21, GRB22H26, GRB22, GRB22H35, GRB22H41, GSB19H15, GSB19H21, GSB19H26, GSB19, GSB19H35 and GSB19H41 attach to tops with a 6" x 6" steel plate, welded to a 3" diameter steel tube, bolted to a 0.5" thick solid steel counter balance.
- Top plate and base plate of GRB22 and GSB19 models in all heights, have pass-through cut-outs to accommodate a single port simplex or dual USB module to deliver power or USB charging to the surface. This allows the module to be mounted directly above the base and to pass the unit's cord through the base column resulting in the cord and plug head exiting from the bottom of the base for plugging into a floor or wall mount power source.
- GRB28, GRB34, GSB23 and GSB28 attach to tops with an 11" x 11" steel plate, welded to a 4" diameter steel tube, bolted to a 0.375" thick solid steel counter balance.
- Bases are available PAINTED in "Sandtex" finish for extra durability. Also available in plated finishes (see page 18) at an upcharge and with an extended lead time. Please see model # for pricing.
- All bases come with six height adjustable glides with 0.75" of adjustability.
- Round bases available in 22", 28" and 34" dia.
- Square bases available in 18.5", 22.5" and 28.5".

S SWAP™ TABLES - HOW TO SPECIFY

1. SPECIFY MODEL NUMBER

2. SPECIFY FINISH

Laminate finishes (high pressure laminate):

ACJ	Absolute Acajou	FCL	First Class
ASN	Asian Night	NBL	Noce Biondo
AWC	Avant Cherry	NGL	Noce Grigio
AWH	Avant Honey	NEL	Noce Leggero
BLK	Black	NML	Noce Medio
BZD	Blizzard	QTM	Quartered Mahogany
BRC	Brushed Cobalt	SBY	Sheer Beauty
CMB	Clear Maple	SDT	Stonedust
CGY	Custom Grey	SOG	Storm Grey
DES	Dark Espresso	WHE	Walnut Heights
DWT	Designer White	WHC	White Chocolate
FAS	Fashionista	WCR	Winter Cherry

Veneer finishes (applicable for models ending in **V** only):

AMW	Almond Cherry	LTW	Latte
ACW	Amber Cherry	MHW	Mahogany on Walnut
BTW	Biscotti	MPW	Natural Maple
CAW	Cocoa Walnut	MTW	Milestone
CRW	Coral	NLW	Natural Walnut
DCW	Dark Cherry	RCW	Red Cherry
DWW	Dark Walnut	ULW	Umber Walnut
EWV	Espresso	VNW	Vintage Cherry
EVW	Evening Oak	WLW	Walnut
GRW	Grey on Oak	WMW	White Maple
HAW	Hazelnut	WCW	Warm Cherry
JAW	Java		

Solid surface (applicable for models ending in **SF** or **SK** only):

Grade 1		Grade 2	
SWH	Designer White	SBT	Beige Tempest
		SBX	Black Onyx Mirage
		SFW	Frosty White Mirage
		SHS	Hot Stone
		SMG	Milk Glass Spectra
		SNM	Northern Melange

Bases (paint finishes):

TBL	Black	TIN	Ink
TBZ	Buzz Blue	TKA	Kalua
TCC	Cactus	TLA	Latte
TCR	Carrot	TMO	Mocha
TIV	Cloud	TNE	Nevada
TDW	Designer White	TSN	Sand
TDJ	Dijon	TSR	Scarlet
TEG	Eggplant	TSH	Shadow
TFO	Fog	TOA	Toast
TFR	Frost	TTU	Tungsten

Bases (plated finishes - upcharge applies):

ACO	Antique Copper	CHM	Chrome
BCH	Brushed Chrome	SBR	Satin Brass

3. SPECIFY EDGE PROFILE (where applicable)

- Thermally fused laminate and high pressure with flat edge tops:
 - Flat edge (FE) - default profile
 - 3" radiused corners (R3) - optional for square and rectangular tops, upcharge applies
- High pressure laminate tops (models ending in **LK**):
 - Knife edge only
 - 3" radiused corners available by quote request only
- Veneer tops (models ending in **V**):
 - Flat edge (FE) - default profile
 - Knife edge (KS) - optional
 - 3" radiused corners available by quote request only
- Solid surface tops (models ending is **SF**):
 - Flat edge (FE) - default profile
 - 3" radiused corners (R3) - optional for square and rectangular tops, upcharge applies
- Solid surface tops (models ending is **SK**):
 - Knife edge (KS) - default profile
 - Knife edge with 3" radiused corners (KR) - optional for square and rectangular tops, upcharge applies

4. SPECIFY EDGE FINISH

Edge finish only applicable for high pressure tops with flat edge (FE)

AAE	Absolute Acajou	CGY	Custom Grey	NML	Noce Medio
ASE	Asian Night	DEE	Dark Espresso	QTM	Quarter Mahogany
ACE	Avant Cherry	DWE	Designer White	SAR	Scarlet
AHE	Avant Honey	DJN	Dijon	SHW	Shadow
BLK	Black	FAS	Fashionista	SBY	Sheer Beauty
BZD	Blizzard	FCL	First Class	SDT	Stonedust
BRC	Brushed Cobalt	FOG	Fog	SOG	Storm Grey
BZB	Buzz Blue	LAB	Latte	WHE	Walnut Heights
CCT	Cactus	NBL	Noce Biondo	CBE	White Chocolate
CRO	Carrot	NGL	Noce Grigio	WCE	Winter Cherry
CME	Clear Maple	NEL	Noce Leggero		

5. SPECIFY OPTIONS

POWER BLOCKS AND CUT-OUTS LOCATIONS

- A power block delivers power/data to the table surface.
- Power block modules are ordered separately.
- Not all power block locations are available on all table sizes. Please refer to the top/base chart on the following pages for more information.
- To purchase a power block, you must specify the power block cut-out location when ordering the top and order the power block separately.
- Optional cut-out available in standard worksurface locations (left, center or right) for all table shapes.
Example: Order a **R1** or **T1**. **Add \$91** for each cut-out.
- Cut-outs may be placed at non-standard locations. Please contact Customer Service.
- Select power block option from Productivity Solutions pages 83-85.
- Custom locations or cut-outs available (drawing required). **Add \$132**.

SPECIFICATIONS

- Required and optional specifications marked with an * on the pricelist pages with products are applicable to only those products which have the * symbol beside the product name.

POWER BLOCK OPTIONS AND CUT-OUT LOCATIONS

(Power modules and blocks can be found in the Productivity Solutions section of the price list)

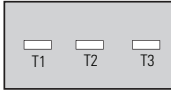







PRTMCS401B PRTMCS401T PRTMCS401W PRTMCS421B PRTMCS421T PRTMCS421W		PRTMCD602B PRTMCD602T PRTMCD602W PRTMCD622B PRTMCD622T PRTMCD622W PRTMCD642B PRTMCD642T PRTMCD642W	
--	---	--	---



- Match power block desired with cut-out code and location from above grid.
- Example: If power block module # PRTMC401B is required in the center position, specify cut-out option R2 when specifying the top.

TABLE NOTES - ESTIMATED CAPACITY

- Use the following to determine the size of a table and the number of chairs needed for a conference area.
- All estimates are based on an average chair width of 23" with a 4" clearance between chairs. Adjust accordingly for a different chair size.

Top Size	Round	NUMBER OF CHAIRS				Boat	Racetrack
		Square	Rectangular				
30 x 30	3	4	N/A	N/A	N/A	N/A	
30 x 36	N/A	N/A	4	N/A	N/A	N/A	
30 x 42	N/A	N/A	4	N/A	N/A	N/A	
36 x 36	4	4	N/A	N/A	N/A	N/A	
36 x 42	N/A	N/A	4	N/A	N/A	N/A	
42 x 42	4	4	N/A	N/A	N/A	N/A	
48 x 48	4	4	N/A	N/A	N/A	N/A	
54 x 54	5	6	N/A	N/A	N/A	N/A	
60 x 60	5	6	N/A	N/A	N/A	N/A	
30 x 60	N/A	N/A	4-6	4-6	4-6	4-6	
30 x 66	N/A	N/A	4-6	4-6	4-6	4-6	
36 x 60	N/A	N/A	4-6	4-6	4-6	4-6	
36 x 66	N/A	N/A	4-6	4-6	4-6	4-6	
36 x 72	N/A	N/A	4-6	4-6	4-6	4-6	
36 x 84	N/A	N/A	4-6	4-6	4-6	4-6	
36 x 96	N/A	N/A	6-8	6-8	6-8	6-8	
48 x 84	N/A	N/A	6-8	6-8	6-8	6-8	
48 x 96	N/A	N/A	6-8	6-8	6-8	6-8	
48 x 120	N/A	N/A	8-10	8-10	8-10	8-10	
48 x 144	N/A	N/A	10-12	10-12	10-12	10-12	

APPLICABLE BASE OPTIONS FOR CORRESPONDING TOP										POWER MGMT OPTIONS		
Table Shape/Size	Top #	Lounge Height 27"H		Seated Height 28.5"H		Counter Height 36"H		Bar Height 41.5"H		Base Qty.	# top pieces	Grommet and Power Block Cut-outs Available
		Round base 22" 	Square base 18.5" 	Round base 22", 28", 34" 	Square base 18.5", 22.5", 28.5" 	Round base 22" 	Square base 18.5" 	Round base 22" 	Square base 18.5" 			
Round ○ Nominal base plate dimension indicated by 4th and 5th characters in base model numbers												
24" diameter top	GRBTP24_	GRB22H26	GSB19H26	GRB22	GSB19	GRB22H35	GSB19H35	GRB22H41	GSB19H41	1	1	Q2 only
30" diameter top	GRBTP30_	GRB22H26	GSB19H26	GRB22	GSB19	GRB22H35	GSB19H35	GRB22H41	GSB19H41	1	1	Q2 only
36" diameter top	GRBTP36_	GRB22H26	GSB19H26	GRB22	GSB19	GRB22H35	GSB19H35	GRB22H41	GSB19H41	1	1	Q2 only
42" diameter top	GRBTP42_	N/A	N/A	GRB28	GSB23	N/A	N/A	N/A	N/A	1	1	None
48" diameter top	GRBTP48_	N/A	N/A	GRB28	GSB23	N/A	N/A	N/A	N/A	1	1	None
54" diameter top	GRBTP54_	N/A	N/A	GRB34	GSB28	N/A	N/A	N/A	N/A	1	1	None
60" diameter top	GRBTP60_	N/A	N/A	GRB34	GSB28	N/A	N/A	N/A	N/A	1	1	None
Square □												
24" square top	GSBTP24_	GRB22H26	GSB19H26	GRB22	GSB19	GRB22H35	GSB19H35	GRB22H41	GSB19H41	1	1	Q2 only
30" square top	GSBTP30_	GRB22H26	GSB19H26	GRB22	GSB19	GRB22H35	GSB19H35	GRB22H41	GSB19H41	1	1	Q2 only
36" square top	GSBTP36_	GRB22H26	GSB19H26	GRB22	GSB19	GRB22H35	GSB19H35	GRB22H41	GSB19H41	1	1	Q2 only
42" square top	GSBTP42_	N/A	N/A	GRB28	GSB23	N/A	N/A	N/A	N/A	1	1	None
Rectangular ▭												
30x24 Rectangular	GSBTP2430_	GRB22H26	GSB19H26	GRB22	GSB19	GRB22H35	GSB19H35	GRB22H41	GSB19H41	1	1	Q2 only
36x24 Rectangular	GSBTP2436_	GRB22H26	GSB19H26	GRB22	GSB19	GRB22H35	GSB19H35	GRB22H41	GSB19H41	1	1	Q2 only
36x30 Rectangular	GSBTP3036_	GRB22H26	GSB19H26	GRB22	GSB19	GRB22H35	GSB19H35	GRB22H41	GSB19H41	1	1	Q2 only
42x30 Rectangular	GSBTP3042_	N/A	N/A	GRB28	GSB23	N/A	N/A	N/A	N/A	1	1	None
42x36 Rectangular	GSBTP3642_	N/A	N/A	GRB28	GSB23	N/A	N/A	N/A	N/A	1	1	None
60x30 Rectangular	GRT5NTP_	GRB22H26	GSB19H26	GRB22	GSB19	GRB22H35	GSB19H35	GRB22H41	GSB19H41	2	1	Center: R2, T2, FOG2
60x36 Rectangular	GRT5TP_	GRB22H26	GSB19H26	GRB22	GSB19	GRB22H35	GSB19H35	GRB22H41	GSB19H41	2	1	
66x30 Rectangular	GRT5NHTP_	GRB22H26	GSB19H26	GRB22	GSB19	GRB22H35	GSB19H35	GRB22H41	GSB19H41	2	1	
66x36 Rectangular	GRT5HTP_	GRB22H26	GSB19H26	GRB22	GSB19	GRB22H35	GSB19H35	GRB22H41	GSB19H41	2	1	
72x36 Rectangular	GRT6TP_	GRB22H26	GSB19H26	GRB22	GSB19	GRB22H35	GSB19H35	GRB22H41	GSB19H41	2	1	
84x36 Rectangular	GRT7TP_	GRB22H26	GSB19H26	GRB22	GSB19	GRB22H35	GSB19H35	GRB22H41	GSB19H41	2	1	3 positions - Left/Center/Right: R1/2/3, T1/2/3, FOG1/2/3
96x36 Rectangular	GRT8TP_	GRB22H26	GSB19H26	GRB22	GSB19	GRB22H35	GSB19H35	GRB22H41	GSB19H41	2	1	
96x42 Rectangular	GRT8MTP_	N/A	N/A	GRB28	GSB23	N/A	N/A	N/A	N/A	2	1	
96x48 Rectangular	GRT8WTP_	N/A	N/A	GRB28	GSB23	N/A	N/A	N/A	N/A	2	1	Both ends: R1, R2, T1, T2, FOG1, FOG3
120x48 Rectangular	GRT10WTP_	N/A	N/A	GRB28	GSB23	N/A	N/A	N/A	N/A	3	2	
144x48 Rectangular	GRT12WTP_	N/A	N/A	GRB28	GSB23	N/A	N/A	N/A	N/A	3	2	

APPLICABLE BASE OPTIONS FOR CORRESPONDING TOP										POWER MGMT OPTIONS		
Table Shape/Size	Top #	Lounge Height 27"H		Seated Height 28.5"H		Counter Height 36"H		Bar Height 41.5"H		Base Qty.	# top pieces	Grommet and Power Block Cut-outs Available
		Round base 22"	Square base 18.5"	Round base 22", 28", 34"	Square base 18.5", 22.5", 28.5"	Round base 22"	Square base 18.5"	Round base 22"	Square base 18.5"			
Racetrack  Nominal base plate dimension indicated by 4th and 5th characters in base model numbers												
60x30 Racetrack	GRC5NTP_	GRB22H26	GSB19H26	GRB22	GSB19	GRB22H35	GSB19H35	GRB22H41	GSB19H41	2	1	Center: R2, T2, FOG2
60X36 Racetrack	GRC5TP_	GRB22H26	GSB19H26	GRB22	GSB19	GRB22H35	GSB19H35	GRB22H41	GSB19H41	2	1	
66x30 Racetrack	GRC5NHTP_	GRB22H26	GSB19H26	GRB22	GSB19	GRB22H35	GSB19H35	GRB22H41	GSB19H41	2	1	
66X36 Racetrack	GRC5HTP_	GRB22H26	GSB19H26	GRB22	GSB19	GRB22H35	GSB19H35	GRB22H41	GSB19H41	2	1	
72x36 Racetrack	GRC6TP_	GRB22H26	GSB19H26	GRB22	GSB19	GRB22H35	GSB19H35	GRB22H41	GSB19H41	2	1	
84x36 Racetrack	GRC7TP_	GRB22H26	GSB19H26	GRB22	GSB19	GRB22H35	GSB19H35	GRB22H41	GSB19H41	2	1	3 positions - Left/Center/Right: R1/2/3, T1/2/3, FOG1/2/3
96x36 Racetrack	GRC8TP_	GRB22H26	GSB19H26	GRB22	GSB19	GRB22H35	GSB19H35	GRB22H41	GSB19H41	2	1	
96x42 Racetrack	GRC8MTP_	N/A	N/A	GRB28	GSB23	N/A	N/A	N/A	N/A	2	1	
96x48 Racetrack	GRC8WTP_	N/A	N/A	GRB28	GSB23	N/A	N/A	N/A	N/A	2	1	Both ends: R1, R3, T1, T3, FOG1, FOG3
120x48 Racetrack	GRC10WTP_	N/A	N/A	GRB28	GSB23	N/A	N/A	N/A	N/A	3	2	
144x48 Racetrack	GRC12WTP_	N/A	N/A	GRB28	GSB23	N/A	N/A	N/A	N/A	3	2	
Boat Shape 												
60x30 Boat shape	GBT5NTP_	GRB22H26	GSB19H26	GRB22	GSB19	GRB22H35	GSB19H35	GRB22H41	GSB19H41	2	1	Center: R2, T2, FOG2
60X36 Boat shape	GBT5TP_	GRB22H26	GSB19H26	GRB22	GSB19	GRB22H35	GSB19H35	GRB22H41	GSB19H41	2	1	
66x30 Boat shape	GBT5NHTP_	GRB22H26	GSB19H26	GRB22	GSB19	GRB22H35	GSB19H35	GRB22H41	GSB19H41	2	1	
66X36 Boat shape	GBT5HTP_	GRB22H26	GSB19H26	GRB22	GSB19	GRB22H35	GSB19H35	GRB22H41	GSB19H41	2	1	
72x36 Boat shape	GBT6TP_	GRB22H26	GSB19H26	GRB22	GSB19	GRB22H35	GSB19H35	GRB22H41	GSB19H41	2	1	
84x36 Boat shape	GBT7TP_	GRB22H26	GSB19H26	GRB22	GSB19	GRB22H35	GSB19H35	GRB22H41	GSB19H41	2	1	3 positions - Left/Center/Right: R1/2/3, T1/2/3, FOG1/2/3
96x36 Boat shape	GBT8TP_	GRB22H26	GSB19H26	GRB22	GSB19	GRB22H35	GSB19H35	GRB22H41	GSB19H41	2	1	
96X42 Boat shape	GBT8MTP_	N/A	N/A	GRB28	GSB23	N/A	N/A	N/A	N/A	2	1	
96x48 Boat shape	GBT8WTP_	N/A	N/A	GRB28	GSB23	N/A	N/A	N/A	N/A	2	1	Both ends: R1, R3, T1, T3, FOG1, FOG3
120x48 Boat shape	GBT10WTP_	N/A	N/A	GRB28	GSB23	N/A	N/A	N/A	N/A	3	2	
144x48 Boat shape	GBT12WTP_	N/A	N/A	GRB28	GSB23	N/A	N/A	N/A	N/A	3	2	

S SWAP™ TABLES - NOTES

APPLICABLE BASE OPTIONS FOR CORRESPONDING TOP						POWER MGMT OPTIONS		
Table Shape/Size	Top #	Laptop Height 25.6" H				Base Qty.	# Top pieces	Power Block Cut-outs available
		Round base 14" Centered column	Square base 12.5" Centered column	Round base	Square base 12.5" Offset column			
Square Laptop <input type="checkbox"/>								
20"x20"	GSBTP20_	GRB14H25	GSB13H25	N/A	N/A	1	1	None
22"x22"	GSBTP22_	GRB14H25	GSB13H25	N/A	N/A	1	1	None
20"x20"	GSBOTP20_	N/A	N/A	N/A	GSOB13H25	1	1	None
22"x22"	GSBOTP22_	N/A	N/A	N/A	GSOB13H25	1	1	None
Rectangular Laptop <input type="checkbox"/>								
16"x20"	GSBTP1620_	GRB14H25	GSB13H25	N/A	N/A	1	1	None
16"x22"	GSBTP1622_	GRB14H25	GSB13H25	N/A	N/A	1	1	None
16"x20"	GSBOT1620_	N/A	N/A	N/A	GSOB13H25	1	1	None
16"x22"	GSBOT1622_	N/A	N/A	N/A	GSOB13H25	1	1	None
APPLICABLE BASE OPTIONS FOR CORRESPONDING TOP						POWER MGMT OPTIONS		
Table Shape	Top #	Coffee Table 16" H		End Table 22" H		Base Qty.	# top pieces	Power Block Cut-outs available
		Round base 22"	Square base 18.5"	Round base 22"	Square base 18.5"			
Round Coffee/End Tables <input type="radio"/> <i>*Nominal base plate dimension indicated by 4th and 5th characters in base model numbers.</i>								
24" dia	GRBTP24_	GRB22H15	GSB19H15	GRB22H21	GSB19H21	1	1	Q2 only
30" dia	GRBTP30_	GRB22H15	GSB19H15	GRB22H21	GSB19H21	1	1	Q2 only
36" dia	GRBTP36_	GRB22H15	GSB19H15	GRB22H21	GSB19H21	1	1	Q2 only
Square Coffee/End Tables <input type="checkbox"/>								
24" square	GSBTP24_	GRB22H15	GSB19H15	GRB22H21	GSB19H21	1	1	Q2 only
30" square	GSBTP30_	GRB22H15	GSB19H15	GRB22H21	GSB19H21	1	1	Q2 only
36" square	GSBTP36_	GRB22H15	GSB19H15	GRB22H21	GSB19H21	1	1	Q2 only

SQUARE LAPTOP TABLES FOR CENTER BASE



MODEL #	DIMENSIONS	WT/LB.	CUBIC FT.	LIST PRICE	GRADE 2	R3 ADD	KS ADD
W x D x H							
High pressure laminate, flat edge ⁽⁴⁾							
GSBTP20 (HP)	20 x 20 x 1	11	0.5	\$295	N/A	\$20.60	N/A
GSBTP22 (HP)	22 x 22 x 1	13	0.5	\$295	N/A	\$20.60	N/A
High pressure laminate, knife edge							
GSBTP20LK	20 x 20 x 1.19	13	1.5	\$450	N/A	N/A	N/A
GSBTP22LK	22 x 22 x 1.19	16	2	\$491	N/A	N/A	N/A
Veneer ⁽²⁾							
GSBTP20V	20 x 20 x 1.19	13	1.5	\$618	N/A	N/A	\$87
GSBTP22V	22 x 22 x 1.19	16	2	\$679	N/A	N/A	\$97
Solid surface, flat edge ⁽³⁾⁽⁴⁾							
GSBTP16SF	16.5 x 16.5 x 1.25	14	0.6	\$1447	\$83	\$206	N/A
GSBTP20SF	20 x 20 x 1.25	21	1	\$1736	\$123	\$206	N/A
GSBTP22SF	22 x 22 x 1.25	26	1	\$1829	\$147	\$206	N/A
Solid surface, knife edge ⁽³⁾⁽⁴⁾							
GSBTP16SK	16.5 x 16.5 x 1.25	14	0.6	\$1789	\$100	\$206	N/A
GSBTP20SK	20 x 20 x 1.25	21	1	\$2088	\$130	\$206	N/A
GSBTP22SK	22 x 22 x 1.25	26	1	\$2188	\$176	\$206	N/A

Only applicable bases to use with above tops: GRB14H25 round base or GSB13H25 square base with centered column. Tops feature metal inserts for ease of assembly to base. One base required.

SQUARE LAPTOP TABLES FOR OFFSET BASE

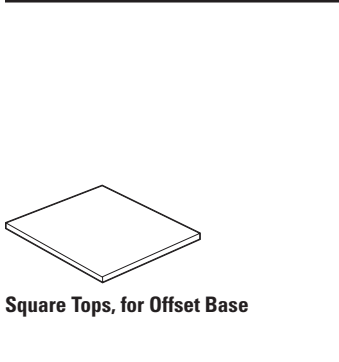

High pressure laminate, flat edge ⁽⁴⁾							
GSBOTP20 (HP)	20 x 20 x 1	11	0.5	\$295	N/A	\$20.60	N/A
High pressure laminate, knife edge							
GSBOTP20LK	20 x 20 x 1.19	13	1.5	\$450	N/A	N/A	N/A
Veneer ⁽²⁾							
GSBOTP20V	20 x 20 x 1.19	13	1.5	\$618	N/A	N/A	\$87

Only applicable bases to use with above tops: GSOB13H25 square base with OFFSET column. Tops feature metal inserts for ease of assembly to base. One base required.

RECTANGULAR LAPTOP TABLES FOR OFFSET BASE

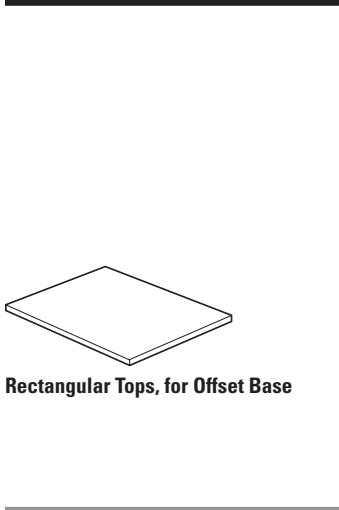

High pressure laminate, flat edge ⁽⁴⁾							
GSBOT1620 (HP)	16 x 20 x 1	9	0.4	\$301	N/A	\$21	N/A
GSBOT1622 (HP)	16 x 22 x 1	11	0.5	\$301	N/A	\$21	N/A
High pressure laminate, knife edge							
GSBOT1620LK	20 x 16 x 1.19	11	1.5	\$461	N/A	N/A	N/A
GSBOT1622LK	22 x 16 x 1.19	13	2	\$506	N/A	N/A	N/A
Veneer ⁽²⁾							
GSBOT1620V	20 x 16 x 1.19	11	1.5	\$608	N/A	N/A	\$87
GSBOT1622V	22 x 16 x 1.19	13	2	\$668	N/A	N/A	\$92

Only applicable bases to use with above tops: GSOB13H25 square base with OFFSET column. Tops feature metal inserts for ease of assembly to base. One base required.

Required specifications	Optional specifications	Applicable bases
Top finish Edge finish ⁽¹⁾	Knife edge ⁽²⁾ Grade 2 solid surface ⁽³⁾ 3" radiused corners ⁽⁴⁾	GRB14H25 - round GSB13H25 - square

S SWAP™ TABLES

LAPTOP TABLE BASES	MODEL #	DIMENSIONS	WT/LB.	CUBIC FT.	LIST PRICE	BCH / CHM	ACO / SBR
--------------------	---------	------------	--------	-----------	------------	-----------	-----------

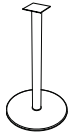

14" Round Centered Base

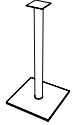

12.5" Square Centered Base

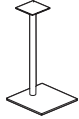

12.5" Square Offset Base

	W x D x H						
GRB14H25	14 x - x 24.6	27	3.26	\$633	\$87	\$172	
GSB13H25	12.5 x 12.5 x 24.6	26	3.26	\$653	\$87	\$186	
GSOB13H25	12.5 x 12.5 x 24.6	26	3.26	\$653	\$87	\$186	

1.5" diameter column. Weighted base for balance includes top plate, 0.5" adjustable glides to level on uneven surfaces. Screws included with base for attaching to appropriate top(s). Available in paint and plated finishes as listed on page 18. Upcharge applies on plated finishes.

Required specifications
Finish

Optional specifications
Plated finish

ROUND TOPS, 24" - 36"W

MODEL # DIMENSIONS WT/LB. CUBIC FT. LIST PRICE GRADE 2 R3 ADD KS ADD

W x D x H

High pressure laminate, flat edge

GRBTP24 (HP)	24 x - x 1	16	1	\$297	N/A	N/A	N/A
GRBTP30 (HP)	30 x - x 1	25	1.5	\$347	N/A	N/A	N/A
GRBTP36 (HP)	36 x - x 1	36	2	\$439	N/A	N/A	N/A

High pressure laminate, knife edge

GRBTP24LK	24 x - x 1.19	19	2	\$845	N/A	N/A	N/A
GRBTP30LK	30 x - x 1.19	30	3	\$1038	N/A	N/A	N/A
GRBTP36LK	36 x - x 1.19	43	4	\$1228	N/A	N/A	N/A

Veneer ⁽²⁾

GRBTP24V	24 x - x 1.19	19	2	\$1079	N/A	N/A	\$77
GRBTP30V	30 x - x 1.19	30	3	\$1286	N/A	N/A	\$77
GRBTP36V	36 x - x 1.19	43	4	\$1505	N/A	N/A	\$77

Solid surface, flat edge ⁽³⁾

GRBTP24SF	24 x - x 1.25	24	1.2	\$2130	\$171	N/A	N/A
GRBTP30SF	29.8 x - x 1.25	37	1.8	\$2323	\$235	N/A	N/A
GRBTP36SF	36 x - x 1.25	53	2.5	\$2970	\$353	N/A	N/A

Solid surface, knife edge ⁽³⁾

GRBTP24SK	24 x - x 1.25	24	1.2	\$2188	\$183	N/A	N/A
GRBTP30SK	29.8 x - x 1.25	37	1.8	\$2411	\$253	N/A	N/A
GRBTP36SK	36 x - x 1.25	53	2.5	\$3147	\$376	N/A	N/A



Round Tops

Applicable bases to use with above tops: GRB22Hxx round base or GSB19Hxx square base (15", 21", 26", 28" 35" or 40.5"H). Tops feature metal inserts for ease of assembly to base. One base required.

SQUARE TOPS, 24" - 36"W

High pressure laminate, flat edge ⁽⁴⁾

GSBTP24 (HP)	24 x 24 x 1	20	1	\$297	N/A	\$20.60	N/A
GSBTP30 (HP)	30 x 30 x 1	30	1.5	\$347	N/A	\$23.90	N/A
GSBTP36 (HP)	36 x 36 x 1	44	2	\$439	N/A	\$30.30	N/A

High pressure laminate, knife edge

GSBTP24LK	24 x 24 x 1.19	24	2	\$768	N/A	N/A	N/A
GSBTP30LK	30 x 30 x 1.19	36	3	\$834	N/A	N/A	N/A
GSBTP36LK	36 x 36 x 1.19	53	4	\$895	N/A	N/A	N/A

Veneer ⁽²⁾

GSBTP24V	24 x 24 x 1.19	24	2	\$1111	N/A	N/A	\$72
GSBTP30V	30 x 30 x 1.19	36	3	\$1177	N/A	N/A	\$72
GSBTP36V	36 x 36 x 1.19	53	4	\$1248	N/A	N/A	\$72

Solid surface, flat edge ^{(3) (4)}

GSBTP24SF	24 x 24 x 1.25	30	1.2	\$1882	\$176	\$206	N/A
GSBTP30SF	29.8 x 29.8 x 1.25	47	1.8	\$2323	\$235	\$206	N/A
GSBTP36SF	36 x 36 x 1.25	68	2.5	\$3024	\$288	\$206	N/A

Solid surface, knife edge ^{(3) (4)}

GSBTP24SK	24 x 24 x 1.25	30	1.2	\$1942	\$188	\$206	N/A
GSBTP30SK	29.8 x 29.8 x 1.25	47	1.8	\$2912	\$265	\$206	N/A
GSBTP36SK	36 x 36 x 1.25	68	2.5	\$3606	\$329	\$206	N/A

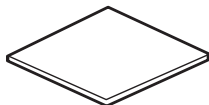

Square Tops

Applicable bases to use with above tops: GRB22Hxx round base or GSB19Hxx square base (15", 21", 26", 28" 35" or 40.5"H). Tops feature metal inserts for ease of assembly to base. One base required.

Required specifications

Top finish
Edge finish ⁽¹⁾

Optional specifications

Knife edge ⁽²⁾
Grade 2 solid surface ⁽³⁾
3" radiused corners ⁽⁴⁾
Q2 cut-out for single port module

Applicable bases

Round bases: GRB22H15, GRB22H21, GRB22H26, GRB22, GRB22H35, GRB22H41
Square bases: GSB19H15, GSB19H21, GSB19H26, GSB19, GSB19H35, GSB19H41

Accessories

Single port modules

RECTANGULAR TOPS, SMALL **MODEL #** **DIMENSIONS** **WT/LB.** **CUBIC FT.** **LIST PRICE** **GRADE 2** **R3 ADD** **KS ADD**

W x D x H

High pressure laminate, flat edge ⁽⁴⁾

GSBTP2430 (HP)	30 x 24 x 1	20	0.91	\$338	N/A	\$23.50	N/A
GSBTP2436 (HP)	36 x 24 x 1	24	1.08	\$388	N/A	\$27.10	N/A
GSBTP3036 (HP)	36 x 30 x 1	31	1.34	\$425	N/A	\$29.70	N/A

High pressure laminate, knife edge

GSBTP2430LK	30 x 24 x 1.19	24	2.5	\$768	N/A	N/A	N/A
GSBTP2436LK	36 x 24 x 1.19	29	3	\$895	N/A	N/A	N/A
GSBTP3036LK	36 x 30 x 1.19	37	3.5	\$942	N/A	N/A	N/A

Veneer ⁽²⁾

GSBTP2430V	30 x 24 x 1.19	24	2.5	\$1111	N/A	N/A	\$72
GSBTP2436V	36 x 24 x 1.19	29	3	\$1177	N/A	N/A	\$72
GSBTP3036V	36 x 30 x 1.19	37	3.5	\$1248	N/A	N/A	\$72

Solid surface, flat edge ⁽³⁾⁽⁴⁾

GSBTP2430SF	24 x 29.8 x 1.25	38	1.8	\$2035	\$176	\$206	N/A
GSBTP2436SF	24 x 36 x 1.25	45	2.1	\$2295	\$223	\$206	N/A
GSBTP3036SF	29.8 x 36 x 1.25	57	2.1	\$2606	\$248	\$206	N/A

Solid surface, knife edge ⁽³⁾⁽⁴⁾

GSBTP2430SK	24 x 29.8 x 1.25	38	1.8	\$2453	\$218	\$206	N/A
GSBTP2436SK	24 x 36 x 1.25	45	2.1	\$2664	\$271	\$206	N/A
GSBTP3036SK	29.8 x 36 x 1.25	57	2.1	\$3006	\$300	\$206	N/A

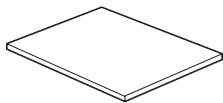

Rectangular Tops

Applicable bases to use with above tops: GRB22Hxx round base or GSB19Hxx square base (15", 21", 26", 28" 35" or 40.5"H). Tops feature metal inserts for ease of assembly to base. One base required.

BASES FOR TOPS 24" - 36"W **MODEL #** **DIMENSIONS** **WT/LB.** **CUBIC FT.** **LIST PRICE** **BCH / CHM** **ACO / SBR**

BASE VALID FOR TOPS ON PAGES 25-26:

GRB22H15	22 x - x 15	47.6	4.69	\$793	\$147	\$211
GRB22H21	22 x - x 21	48.6	6.45	\$793	\$147	\$211
GRB22H26	22 x - x 26	55	8.63	\$793	\$147	\$221
GRB22	22 x - x 27.5	55	9.33	\$793	\$147	\$221
GRB22H35	22 x - x 35	57.1	12	\$831	\$164	\$253
GRB22H41	22 x - x 40.5	58.3	14	\$844	\$171	\$259

GRB22H15 - coffee table height **GRB22H26** - lounge height **GRB22H35** - counter height
GRB22H21 - end table height **GRB22** - seated height **GRB22H41** - bar height

GSB19H15	18.5 x 18.5 x 15	43.7	3.52	\$857	\$136	\$204
GSB19H21	18.5 x 18.5 x 21	44.8	4.84	\$857	\$136	\$204
GSB19H26	18.5 x 18.5 x 26	50	5.94	\$857	\$136	\$212
GSB19	18.5 x 18.5 x 27.5	50	6.06	\$857	\$136	\$212
GSB19H35	18.5 x 18.5 x 35	51.8	7.52	\$906	\$151	\$262
GSB19H41	18.5 x 18.5 x 40.5	53.2	8.77	\$937	\$166	\$267

GSB19H15 - coffee table height **GSB19H26** - lounge height **GSB1935** - counter height
GSB19H21 - end table height **GSB19** - seated height **GSB19H41** - bar height

Base comes fully assembled and features 0.5" adjustable glides to level on uneven surfaces. Screws included with base for attaching to appropriate top(s). Base top plate and base plate include pass-through for single port power or USB module (sold separately). Available in paint and plated finishes as listed on page 18. Upcharge applies on plated finishes.

Unless otherwise specified, GRB22H26, GSB19H26, GRB22H35, GRB22H41, GSB19H35 and GSB19H41 may only be used on minimum 30"W and 30"D surfaces.

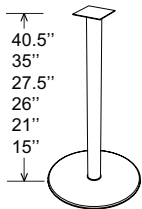

22" Dia Round Bases ⁽¹⁾

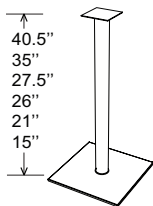

18.5" Square Bases ⁽¹⁾

Required specifications

Top finish
 Edge finish ⁽¹⁾
 Base finish

Optional specifications

Knife edge ⁽²⁾ Grade 2 solid surface ⁽³⁾
 3" radiused corners ⁽⁴⁾
 Q2 cut-out for single port module
 Base plated finish

Applicable bases

Round bases: GRB22H15, GRB22H21, GRB22H26, GRB22, GRB22H35, GRB22H41
 Square bases: GSB19H15, GSB19H21, GSB19H26, GSB19, GSB19H35, GSB19H41

Accessories

Single port modules

ROUND TOPS, 42" - 48"W **MODEL #** **DIMENSIONS** **WT/LB.** **CUBIC FT.** **LIST PRICE** **GRADE 2** **R3 ADD** **KS ADD**

W x D x H

High pressure laminate, flat edge

GRBTP42 (HP)	42 x - x 1	44	2.5	\$598	N/A	N/A	N/A
GRBTP48 (HP)	48 x - x 1	56	3	\$640	N/A	N/A	N/A

High pressure laminate, knife edge

GRBTP42LK	42 x - x 1.19	53	5	\$1432	N/A	N/A	N/A
GRBTP48LK	48 x - x 1.19	67	6.5	\$1637	N/A	N/A	N/A

Veneer ⁽²⁾

GRBTP42V	42 x - x 1.19	53	5	\$1838	N/A	N/A	\$72
GRBTP48V	48 x - x 1.19	67	6.5	\$2103	N/A	N/A	\$81

Solid surface, flat edge ⁽³⁾

GRBTP42SF	42 x - x 1.25	73	3.4	\$4029	\$453	N/A	N/A
GRBTP48SF	48 x - x 1.25	95	4.3	\$4588	\$576	N/A	N/A

Solid surface, knife edge ⁽³⁾

GRBTP42SK	42 x - x 1.25	73	3.4	\$4242	\$506	N/A	N/A
GRBTP48SK	48 x - x 1.25	95	4.3	\$5117	\$641	N/A	N/A



Round Tops

Applicable bases to use with above tops: GRB28 round base or GSB23 square base (28"H). Tops feature metal inserts for ease of assembly to base. One base required.

SQUARE/RECTANGULAR TOPS, 42"W

High pressure laminate, flat edge ⁽⁴⁾

GSBTP3042 (HP)	42 x 30 x 1	36	1.55	\$561	N/A	\$39.20	N/A
GSBTP3642 (HP)	42 x 36 x 1	43	1.86	\$603	N/A	\$42.10	N/A
GSBTP42 (HP)	42 x 42 x 1	58	2.5	\$598	N/A	\$42.40	N/A

High pressure laminate, knife edge

GSBTP3042LK	42 x 30 x 1.19	43	4	\$1013	N/A	N/A	N/A
GSBTP3642LK	42 x 36 x 1.19	52	4.5	\$1075	N/A	N/A	N/A
GSBTP42LK	42 x 42 x 1.19	70	5	\$1120	N/A	N/A	N/A

Veneer ⁽²⁾

GSBTP3042V	42 x 30 x 1.19	43	4	\$1363	N/A	N/A	\$56
GSBTP3642V	42 x 36 x 1.19	52	4.5	\$1423	N/A	N/A	\$66
GSBTP42V	42 x 42 x 1.19	70	5	\$1669	N/A	N/A	\$72

Solid surface, flat edge ⁽³⁾⁽⁴⁾

GSBTP3042SF	29.8 x 42 x 1.25	66	2.9	\$2736	\$300	\$206	N/A
GSBTP3642SF	36 x 42 x 1.25	79	2.9	\$3511	\$400	\$206	N/A
GSBTP42SF	42 x 42 x 1.25	92	3.4	\$3659	\$436	\$206	N/A

Solid surface, knife edge ⁽³⁾⁽⁴⁾

GSBTP3042SK	29.8 x 42 x 1.25	66	2.9	\$3205	\$353	\$206	N/A
GSBTP3642SK	36 x 42 x 1.25	79	2.9	\$4052	\$476	\$206	N/A
GSBTP42SK	42 x 42 x 1.25	92	3.4	\$4242	\$529	\$206	N/A

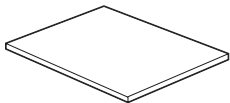

Rectangular Tops

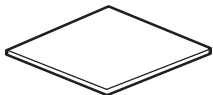

Square Tops

Applicable bases to use with above tops: GRB28 round base or GSB23 square base (28"H). Tops feature metal inserts for ease of assembly to base. One base required.

Required specifications

Top finish
Edge finish ⁽¹⁾

Optional specifications

Knife edge ⁽²⁾
Grade 2 solid surface ⁽³⁾
3" radiused corners ⁽⁴⁾

Applicable bases

GRB28 - round
GSB23 - square

S SWAP™ TABLES

BASES FOR TOPS 42" - 48"W

MODEL # DIMENSIONS WT/LB. CUBIC FT. LIST PRICE BCH / CHM ACO / SBR

W x D x H

BASES VALID FOR TOPS ON PAGE 27:

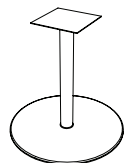

28" Dia Round Base

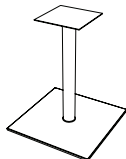

23" Square Base

GRB28	28 x - x 27.5	100	15.63	\$1250	\$147	\$372
seated height						

GSB23	22.5 x 22.5 x 27.5	82	9.33	\$1146	\$136	\$235
seated height						

Base comes fully assembled and features 0.5" adjustable glides to level on uneven surfaces. Screws included with base for attaching to appropriate top(s). Available in paint and plated finishes as listed on page 18. Upcharge applies on plated finishes.

Required Specifications
Finish

Optional Specifications
Plated finish

ROUND TOPS, 54" - 60"W **MODEL #** **DIMENSIONS** **WT/LB.** **CUBIC FT.** **LIST PRICE** **GRADE 2** **R3 ADD** **KS ADD**

W x D x H

High pressure laminate, flat edge

GRBTP54 (HP)	54 x - x 1	73	4.5	\$874	N/A	N/A	N/A
GRBTP60 (HP)	60 x - x 1	92	5	\$909	N/A	N/A	N/A

High pressure laminate, knife edge

GRBTP54LK	54 x - x 1.19	88	8	\$1847	N/A	N/A	N/A
GRBTP60LK	60 x - x 1.19	110	10	\$2276	N/A	N/A	N/A

Veneer ⁽²⁾

GRBTP54V	54 x - x 1.19	88	8	\$2682	N/A	N/A	\$97
GRBTP60V	60 x - x 1.19	110	10	\$3311	N/A	N/A	\$102

Solid surface, flat edge ⁽³⁾

GRBTP54SF	54 x - x 1.25	120	5.4	\$4971	\$706	N/A	N/A
GRBTP60SF	60 x - x 1.25	148	6.7	\$6530	\$882	N/A	N/A

Solid surface, knife edge ⁽³⁾

GRBTP54SK	54 x - x 1.25	120	5.4	\$5876	\$888	N/A	N/A
GRBTP60SK	60 x - x 1.25	148	6.7	\$7189	\$1077	N/A	N/A



Round Tops

Applicable bases to use with above tops: GRB34 round base or GSB28 square base (28"H). Tops feature metal inserts for ease of assembly to base. One base required.

BASES FOR TOPS 54" - 60"W **MODEL #** **DIMENSIONS** **WT/LB.** **CUBIC FT.** **LIST PRICE** **BCH / CHM** **ACO / SBR**

W x D x H

BASES VALID FOR TOPS ABOVE:

Order the quantity of bases as indicated by each top size.

GRB34	34 x - x 27.5	135	20.56	\$1538	\$147	\$449
-------	---------------	-----	-------	---------------	--------------	--------------

seated height

GSB28	28.5 x 28.5 x 27.5	125	15.63	\$1432	\$136	\$242
-------	--------------------	-----	-------	---------------	--------------	--------------

seated height

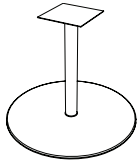

34" Dia Round Base

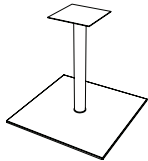

28" Square Base

Base comes fully assembled and features 0.5" adjustable glides to level on uneven surfaces. Screws included with base for attaching to appropriate top(s). Available in paint and plated finishes as listed on page 18. Upcharge applies on plated finishes.

Required specifications

Top finish
Edge finish ⁽¹⁾
Base finish

Optional specifications

Knife edge ⁽²⁾
Grade 2 solid surface ⁽³⁾
Base plated finish

Applicable bases

GRB34 - round
GSB28 - square

RECTANGULAR TOPS, 60" - 96"W

MODEL # DIMENSIONS WT/LB. CUBIC FT. LIST PRICE GRADE 2 R3 ADD KS ADD

W x D x H

High pressure laminate, flat edge ⁽⁴⁾

GRT5NTP (HP)	60 x 30 x 1	46	2.5	\$587	N/A	\$41.40	N/A
GRT5NHTP (HP)	66 x 30 x 1	56	2.44	\$627	N/A	\$44.30	N/A
GRT5TP (HP)	60 x 36 x 1	70	6.6	\$660	N/A	\$47.20	N/A
GRT5HTP (HP)	66 x 36 x 1	79	7.21	\$676	N/A	\$48.10	N/A
GRT6TP (HP)	72 x 36 x 1	72	8	\$676	N/A	\$48.10	N/A
GRT7TP (HP)	84 x 36 x 1	85	8.75	\$832	N/A	\$59.10	N/A
GRT8TP (HP)	96 x 36 x 1	94	9	\$923	N/A	\$64.80	N/A

High pressure laminate, knife edge

GRT5NTPLK	60 x 30 x 1.19	55	5	\$1218	N/A	N/A	N/A
GRT5NHTPLK	66 x 30 x 1.19	67	5.5	\$1330	N/A	N/A	N/A
GRT5TPLK	60 x 36 x 1.19	84	6	\$1448	N/A	N/A	N/A
GRT5HTPLK	66 x 36 x 1.19	95	6.5	\$1581	N/A	N/A	N/A
GRT6TPLK	72 x 36 x 1.19	86	7	\$1719	N/A	N/A	N/A
GRT7TPLK	84 x 36 x 1.19	102	8	\$1990	N/A	N/A	N/A
GRT8TPLK	96 x 36 x 1.19	113	9	\$2266	N/A	N/A	N/A

Veneer ⁽²⁾

GRT5NTPV	60 x 30 x 1.19	55	5	\$1779	N/A	N/A	\$77
GRT5NHTPV	66 x 30 x 1.19	67	5.5	\$1894	N/A	N/A	\$77
GRT5TPV	60 x 36 x 1.19	84	6	\$2031	N/A	N/A	\$97
GRT5HTPV	66 x 36 x 1.19	95	6.5	\$2217	N/A	N/A	\$128
GRT6TPV	72 x 36 x 1.19	86	7	\$2409	N/A	N/A	\$143
GRT7TPV	84 x 36 x 1.19	102	8	\$2797	N/A	N/A	\$164
GRT8TPV	96 x 36 x 1.19	113	9	\$3191	N/A	N/A	\$179

Solid surface, flat edge ⁽³⁾⁽⁴⁾

GRT5NTPSF	60 x 29.8 x 1.25	94	3.4	\$4106	\$436	\$206	N/A
GRT5NHTPSF	66 x 29.8 x 1.25	104	3.8	\$4406	\$506	\$206	N/A
GRT5TPSF	60 x 36 x 1.25	113	4.1	\$5465	\$647	\$206	N/A
GRT5HTPSF	66 x 36 x 1.25	124	4.5	\$5641	\$647	\$206	N/A
GRT6TPSF	71.8 x 36 x 1.25	135	4.9	\$6229	\$706	\$206	N/A
GRT7TPSF	84 x 36 x 1.25	158	5.7	\$6776	\$853	\$206	N/A
GRT8TPSF	96 x 36 x 1.25	180	6.5	\$7271	\$894	\$206	N/A

Solid surface, knife edge ⁽³⁾⁽⁴⁾

GRT5NTPSK	60 x 29.8 x 1.25	94	3.4	\$4494	\$494	\$206	N/A
GRT5NHTPSK	66 x 29.8 x 1.25	104	3.8	\$4853	\$576	\$206	N/A
GRT5TPSK	60 x 36 x 1.25	113	4.1	\$6053	\$729	\$206	N/A
GRT5HTPSK	66 x 36 x 1.25	124	4.5	\$6206	\$741	\$206	N/A
GRT6TPSK	71.8 x 36 x 1.25	135	4.9	\$6876	\$812	\$206	N/A
GRT7TPSK	84 x 36 x 1.25	158	5.7	\$7429	\$970	\$206	N/A
GRT8TPSK	96 x 36 x 1.25	180	6.5	\$7911	\$1023	\$206	N/A

Applicable bases to use with above tops - two bases required: GRB22H26, GRB22, GRB22H35, GRB22H41 round bases or GSB19H26, GSB19, GSB19H35, GSB19H41 square bases. Tops feature metal inserts for ease of assembly to base.

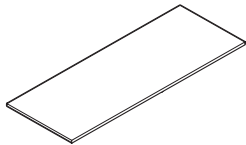

Rectangular Tops

Required specifications

Top finish
Edge finish ⁽¹⁾

Optional specifications

Knife edge ⁽²⁾
Grade 2 solid surface ⁽³⁾
3" radiused corners ⁽⁴⁾
Grommet position or power block cut-out

Applicable bases (two required)

Round bases:
GRB22H26, GRB22, GRB22H35, GRB22H41
Square bases:
GSB19H26, GSB19, GSB19H35, GSB19H41

Accessories

Power block

RACETRACK TOPS, 60" - 96"W MODEL # DIMENSIONS WT/LB. CUBIC FT. LIST PRICE KS ADD

W x D x H

High pressure laminate, flat edge

GRC5NTP (HP)	60 x 30 x 1	46	2.5	\$600	N/A
GRC5NHTP (HP)	66 x 30 x 1	56	2.44	\$644	N/A
GRC5TP (HP)	60 x 36 x 1	70	6.6	\$678	N/A
GRC5HTP (HP)	66 x 36 x 1	79	7.21	\$687	N/A
GRC6TP (HP)	72 x 36 x 1	72	7.5	\$687	N/A
GRC7TP (HP)	84 x 36 x 1	85	8.75	\$844	N/A
GRC8TP (HP)	96 x 36 x 1	94	9	\$934	N/A

High pressure laminate, knife edge

GRC5NTPLK	60 x 30 x 1.19	55	5	\$1673	N/A
GRC5NHTPLK	66 x 30 x 1.19	67	5.5	\$1826	N/A
GRC5TPLK	60 x 36 x 1.19	84	6	\$1826	N/A
GRC5HTPLK	66 x 36 x 1.19	95	6.5	\$1980	N/A
GRC6TPLK	72 x 36 x 1.19	86	7	\$2144	N/A
GRC7TPLK	84 x 36 x 1.19	102	8	\$2451	N/A
GRC8TPLK	96 x 36 x 1.19	113	9	\$2758	N/A

Veneer ⁽²⁾

GRC5NTPV	60 x 30 x 1.19	55	5	\$2014	\$271
GRC5NHTPV	66 x 30 x 1.19	67	5.5	\$2168	\$292
GRC5TPV	60 x 36 x 1.19	84	6	\$2327	\$312
GRC5HTPV	66 x 36 x 1.19	95	6.5	\$2540	\$343
GRC6TPV	72 x 36 x 1.19	86	7	\$2758	\$373
GRC7TPV	84 x 36 x 1.19	102	8	\$3208	\$435
GRC8TPV	96 x 36 x 1.19	113	9	\$3656	\$496

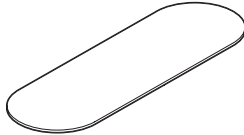

Racetrack Tops

Applicable bases to use with above tops - two bases required: GRB22H26, GRB22, GRB22H35, GRB22H41 round bases or GSB19H26, GSB19, GSB19H35, GSB19H41 square bases. Tops feature metal inserts for ease of assembly to base.

Required specifications

Top finish
Edge finish ⁽¹⁾

Optional specifications

Knife edge ⁽²⁾
Grommet position or power block cut-out

Applicable bases (two required)

Round bases:
GRB22H26, GRB22, GRB22H35, GRB22H41
Square bases:
GSB19H26, GSB19, GSB19H35, GSB19H41

Accessories

Power block

BOAT SHAPE TOPS, 60" - 96"W

MODEL # DIMENSIONS WT/LB. CUBIC FT. LIST PRICE KS ADD

W x D x H

High pressure laminate, flat edge

GBT5NTP (HP)	60 x 30 x 1	46	2.5	\$600	N/A
GBT5NHTP (HP)	66 x 30 x 1	56	2.44	\$644	N/A
GBT5TP (HP)	60 x 36 x 1	70	6.6	\$678	N/A
GBT5HTP (HP)	66 x 36 x 1	79	7.21	\$687	N/A
GBT6TP (HP)	72 x 36 x 1	72	7.5	\$687	N/A
GBT7TP (HP)	84 x 36 x 1	85	8.75	\$844	N/A
GBT8TP (HP)	96 x 36 x 1	94	9	\$934	N/A

High pressure laminate, knife edge

GBT5NTPLK	60 x 30 x 1.19	55	5	\$1673	N/A
GBT5NHTPLK	66 x 30 x 1.19	67	5.5	\$1826	N/A
GBT5TPLK	60 x 36 x 1.19	84	6	\$1826	N/A
GBT5HTPLK	66 x 36 x 1.19	95	6.5	\$1980	N/A
GBT6TPLK	72 x 36 x 1.19	86	7	\$2144	N/A
GBT7TPLK	84 x 36 x 1.19	102	8	\$2451	N/A
GBT8TPLK	96 x 36 x 1.19	113	9	\$2758	N/A

Veneer ⁽²⁾

GBT5NTPV	60 x 30 x 1.19	55	5	\$2014	\$271
GBT5NHTPV	66 x 30 x 1.19	67	5.5	\$2168	\$292
GBT5TPV	60 x 36 x 1.19	84	6	\$2327	\$312
GBT5HTPV	66 x 36 x 1.19	95	6.5	\$2540	\$343
GBT6TPV	72 x 36 x 1.19	86	7	\$2758	\$373
GBT7TPV	84 x 36 x 1.19	102	8	\$3208	\$435
GBT8TPV	96 x 36 x 1.19	113	9	\$3656	\$496

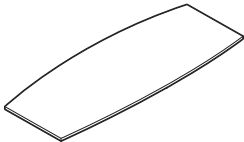

Boat Shape Tops

Applicable bases to use with above tops - two bases required: GRB22H26, GRB22, GRB22H35, GRB22H41 round bases or GSB19H26, GSB19, GSB19H35, GSB19H41 square bases. Tops feature metal inserts for ease of assembly to base.

- GBTxNTP/GBTxNHTP: 30"D across center and 24"D at ends.
- GBTxTP/GBTxHTP: 36"D across center and 28"D at ends.

BASES FOR TOPS 60" - 96"W

MODEL # DIMENSIONS WT/LB. CUBIC FT. LIST PRICE BCH / CHM ACO / SBR

Order the quantity of bases as indicated by each top size.

GRB22H26	22 x - x 26	55	8.63	\$793	\$147	\$221
GRB22	22 x - x 27.5	55	9.33	\$793	\$147	\$221
GRB22H35	22 x - x 35	57.1	12	\$831	\$164	\$253
GRB22H41	22 x - x 40.5	58.3	14	\$844	\$171	\$259

GRB22H26 - lounge height **GRB22** - seated height **GRB22H35** - counter height **GRB22H41** - bar height

GSB19H26	18.5 x 18.5 x 26	50	5.94	\$857	\$136	\$212
GSB19	18.5 x 18.5 x 27.5	50	6.06	\$857	\$136	\$212
GSB19H35	18.5 x 18.5 x 35	51.8	7.52	\$906	\$151	\$262
GSB19H41	18.5 x 18.5 x 40.5	53.2	8.77	\$937	\$166	\$267

GSB19H26 - lounge height **GSB19** - seated height **GSB19H35** - counter height **GSB19H41** - bar height

Base comes fully assembled and features 0.5" adjustable glides to level on uneven surfaces. Screws included with base for attaching to appropriate top(s). Available in paint and plated finishes as listed on page 18. Upcharge applies on plated finishes.

Unless otherwise specified, GRB22H26, GSB19H26, GRB22H35, GSB19H35, GRB22H41 and GSB19H41 may only be used on tables widths of 72" or less.

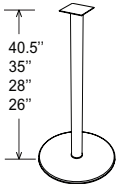

22" Dia Round Bases

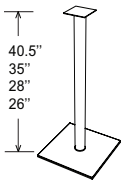

18.5" Square Bases

Required specifications

Top finish
Edge finish ⁽¹⁾

Optional specifications

Knife edge ⁽²⁾
Grommet position or power block cut-out

Applicable bases (two required)

Round bases:
GRB22H26, GRB22, GRB22H35, GRB22H41
Square bases:
GSB19H26, GSB19, GSB19H35, GSB19H41

Accessories

Power block

RECTANGULAR TOPS, 96" - 144"W

MODEL #	DIMENSIONS	WT/LB.	CUBIC FT.	LIST PRICE	R3 ADD	KS ADD
W x D x H						
High pressure laminate, flat edge (1 piece top - 2 bases required) ⁽⁴⁾						
GRT8MTP (HP)	96 x 42 x 1	128	11.84	\$1725	\$122.10	N/A
GRT8WTP (HP)	96 x 48 x 1	190	14	\$1733	\$122.10	N/A
High pressure laminate, flat edge (2 piece tops - 3 bases required) ⁽⁴⁾						
GRT10WTP (HP)	120 x 48 x 1	220	17	\$2173	\$153.70	N/A
GRT12WTP (HP)	144 x 48 x 1	262	21	\$2530	\$179.10	N/A
High pressure laminate, knife edge (1 piece top - 2 bases required)						
GRT8MTPLK	96 x 42 x 1.19	154	11	\$3069	N/A	N/A
GRT8WTPLK	96 x 48 x 1.19	228	12	\$3432	N/A	N/A
High pressure laminate, knife edge (2 piece tops - 3 bases required)						
GRT10WTPLK	120 x 48 x 1.19	264	15	\$4630	N/A	N/A
GRT12WTPLK	144 x 48 x 1.19	314	18	\$5524	N/A	N/A
Veneer (1 piece top - 2 bases required) ⁽²⁾						
GRT8MTPV	96 x 42 x 1.19	154	11	\$4176	N/A	\$378
GRT8WTPV	96 x 48 x 1.19	228	12	\$4696	N/A	\$430
Veneer (2 piece tops - 3 bases required) ⁽²⁾						
GRT10WTPV	120 x 48 x 1.19	264	15	\$6228	N/A	\$573
GRT12WTPV	144 x 48 x 1.19	314	18	\$7439	N/A	\$685

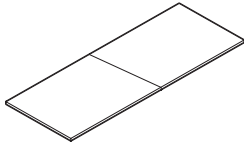

Rectangular Tops

Applicable bases to use with above tops: GRB28 round base or GSB23 square base (28" H).
Two bases required for 96"W tops or three bases required for 120" and 144"W tops.
 Tops feature metal inserts for ease of assembly to base.

RACETRACK TOPS, 96" - 144"W

High pressure laminate, flat edge (1 piece top - 2 bases required)						
GRC8MTP (HP)	96 x 42 x 1	128	11.84	\$1744	N/A	N/A
GRC8WTP (HP)	96 x 48 x 1	190	14	\$1752	N/A	N/A
High pressure laminate, flat edge (2 piece tops - 3 bases required)						
GRC10WTP (HP)	120 x 48 x 1	220	17	\$2196	N/A	N/A
GRC12WTP (HP)	144 x 48 x 1	262	21	\$2557	N/A	N/A
High pressure laminate, knife edge (1 piece top - 2 bases required)						
GRC8MTPLK	96 x 42 x 1.19	154	11	\$3658	N/A	N/A
GRC8WTPLK	96 x 48 x 1.19	228	12	\$4169	N/A	N/A
High pressure laminate, knife edge (2 piece tops - 3 bases required)						
GRC10WTPLK	120 x 48 x 1.19	264	15	\$5192	N/A	N/A
GRC12WTPLK	144 x 48 x 1.19	314	18	\$6215	N/A	N/A
Veneer (1 piece top - 2 bases required) ⁽²⁾						
GRC8MTPV	96 x 42 x 1.19	154	11	\$4954	N/A	\$455
GRC8WTPV	96 x 48 x 1.19	228	12	\$5501	N/A	\$506
Veneer (2 piece tops - 3 bases required) ⁽²⁾						
GRC10WTPV	120 x 48 x 1.19	264	15	\$6727	N/A	\$666
GRC12WTPV	144 x 48 x 1.19	314	18	\$7954	N/A	\$788

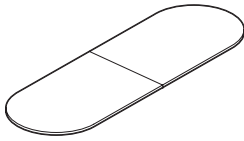

Racetrack Tops

Applicable bases to use with above tops: GRB28 round base or GSB23 square base (28" H).
Two bases required for 96"W tops or three bases required for 120" and 144"W tops.
 Tops feature metal inserts for ease of assembly to base.

Required specifications	Optional specifications	Applicable bases (two or three required)	Accessories
Top finish Edge finish ⁽¹⁾	Knife edge ⁽²⁾ 3" radiused corners ⁽⁴⁾ Grommet position or power block cut-out	GRB28 - round GSB23 - square	Power block

BOAT SHAPE TOPS, 96" - 144"W

MODEL #	DIMENSIONS	WT/LB.	CUBIC FT.	LIST PRICE	KS ADD
---------	------------	--------	-----------	------------	--------

W x D x H

High pressure laminate, flat edge (1 piece top - 2 bases required)

GBT8MTP (HP)	96 x 42 x 1	128	11.84	\$1744	N/A
GBT8WTP (HP)	96 x 48 x 1	190	14	\$1752	N/A

High pressure laminate, flat edge (2 piece tops - 3 bases required)

GBT10WTP (HP)	120 x 48 x 1	220	17	\$2196	N/A
GBT12WTP (HP)	144 x 48 x 1	262	21	\$2557	N/A

High pressure laminate, knife edge (1 piece top - 2 bases required)

GBT8MTPLK	96 x 42 x 1.19	154	11	\$3658	N/A
GBT8WTPLK	96 x 48 x 1.19	228	12	\$4169	N/A

High pressure laminate, knife edge (2 piece tops - 3 bases required)

GBT10WTPLK	120 x 48 x 1.19	264	15	\$5192	N/A
GBT12WTPLK	144 x 48 x 1.19	314	18	\$6215	N/A

Veneer (1 piece top - 2 bases required) ⁽²⁾

GBT8MTPV	96 x 42 x 1.19	154	11	\$4954	\$455
GBT8WTPV	96 x 48 x 1.19	228	12	\$5501	\$506

Veneer (2 piece tops - 3 bases required) ⁽²⁾

GBT10WTPV	120 x 48 x 1.19	264	15	\$7198	\$666
GBT12WTPV	144 x 48 x 1.19	314	18	\$8511	\$788

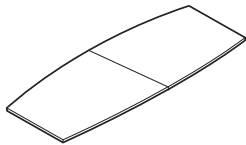

Boat Shape Tops

Applicable bases to use with above tops: GRB28 round base or GSB23 square base (28"H).

Two bases required for 96"W tops or three bases required for 120" and 144"W tops.

Tops feature metal inserts for ease of assembly to base.

- GBTxMTP: 42"D at center and 33"D at ends.
- GBTxxWTP: 48"D at center and 38"D at ends.

BASES FOR TOPS 60" - 96"W

MODEL #	DIMENSIONS	WT/LB.	CUBIC FT.	LIST PRICE	BCH / CHM	ACO / SBR
---------	------------	--------	-----------	------------	-----------	-----------

W x D x H

BASE VALID FOR TOPS ON PAGES 33-34:

Order the quantity of bases as indicated by each top size.

GRB28	28 x - x 27.5	100	15.63	\$1250	\$147	\$372
-------	---------------	-----	-------	---------------	--------------	--------------

seated height

GSB23	22.5 x 22.5 x 27.5	82	9.33	\$1146	\$136	\$235
-------	--------------------	----	------	---------------	--------------	--------------

seated height

Base comes fully assembled and features 0.5" adjustable glides to level on uneven surfaces. Screws included with base for attaching to appropriate top(s). Available in paint and plated finishes as listed on page 18. Upcharge applies on plated finishes.

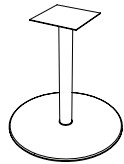

28" Dia Round Base

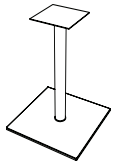

23" Square Base

Required specifications

Top finish
Edge finish ⁽¹⁾
Base finish

Optional specifications

Knife edge ⁽²⁾
Grommet position or power block cut-out
Base plated finish

Applicable bases (two or three required)

GRB28 - round
GSB23 - square

Accessories

Power block

RECTANGULAR TOPS FOR DUAL COLUMN BASE

MODEL #	DIMENSIONS W x D x H	WT/LB.	CUBIC FT.	LIST PRICE	R3 ADD	KS ADD
High pressure laminate, flat edge ⁽⁴⁾						
GRTD5TP (HP)	60 x 36 x 1	60	6.6	\$660	\$47.20	N/A
GRTD5HTP (HP)	66 x 36 x 1	69	7.21	\$676	\$48.10	N/A
GRTD6TP (HP)	72 x 36 x 1	75	7.82	\$676	\$48.10	N/A
GRTD5MTP (HP)	60 x 42 x 1	73	7.62	\$906	\$63.30	N/A
GRTD5HMTP (HP)	66 x 42 x 1	81	8.32	\$969	\$67.50	N/A
GRTD6MTP (HP)	72 x 42 x 1	89	9.02	\$994	\$69.40	N/A
High pressure laminate, knife edge						
GRTD5TPLK	60 x 36 x 1.19	72	6	\$1448	N/A	N/A
GRTD5HTPLK	66 x 36 x 1.19	83	6.5	\$1581	N/A	N/A
GRTD6TPLK	72 x 36 x 1.19	90	7	\$1719	N/A	N/A
GRTD5MTPLK	60 x 42 x 1.19	88	7	\$1668	N/A	N/A
GRTD5HMTPK	66 x 42 x 1.19	97	7.5	\$1832	N/A	N/A
GRTD6MTPLK	72 x 42 x 1.19	107	8	\$1990	N/A	N/A
Veneer ⁽²⁾						
GRTD5TPV	60 x 36 x 1.19	72	6	\$2031	N/A	\$184
GRTD5HTPV	66 x 36 x 1.19	83	6.5	\$2217	N/A	\$199
GRTD6TPV	72 x 36 x 1.19	90	7	\$2409	N/A	\$215
GRTD5MTPV	60 x 42 x 1.19	88	7	\$2349	N/A	\$210
GRTD5HMTPV	66 x 42 x 1.19	97	7.5	\$2573	N/A	\$230
GRTD6MTPV	72 x 42 x 1.19	107	8	\$2797	N/A	\$256



Rectangular Tops

Tops feature metal inserts for ease of assembly to base. One dual column base (**GDCB36H28**) required. Limited cut-out options available for power modules, include E2 or FOG2 only. Power modules corresponding to applicable cut-out codes ordered separately.

RACETRACK TOPS FOR DUAL COLUMN BASE

High pressure laminate, flat edge						
GRCD5TP (HP)	60 x 36 x 1	60	6.6	\$678	N/A	N/A
GRCD5HTP (HP)	66 x 36 x 1	69	7.21	\$687	N/A	N/A
GRCD6TP (HP)	72 x 36 x 1	75	7.82	\$687	N/A	N/A
GRCD5MTP (HP)	60 x 42 x 1	73	7.62	\$906	N/A	N/A
GRCD5HMTP (HP)	66 x 42 x 1	81	8.32	\$969	N/A	N/A
GRCD6MTP (HP)	72 x 42 x 1	89	9.02	\$994	N/A	N/A
High pressure laminate, knife edge						
GRCD5TPLK	60 x 36 x 1.19	72	6	\$1995	N/A	N/A
GRCD5HTPLK	66 x 36 x 1.19	83	6.5	\$2123	N/A	N/A
GRCD6TPLK	72 x 36 x 1.19	90	7	\$2251	N/A	N/A
GRCD5MTPLK	60 x 42 x 1.19	88	7	\$2379	N/A	N/A
GRCD5HMTPK	66 x 42 x 1.19	97	7.5	\$2507	N/A	N/A
GRCD6MTPLK	72 x 42 x 1.19	107	8	\$2635	N/A	N/A
Veneer ⁽²⁾						
GRCD5TPV	60 x 36 x 1.19	72	6	\$2546	N/A	\$230
GRCD5HTPV	66 x 36 x 1.19	83	6.5	\$2682	N/A	\$241
GRCD6TPV	72 x 36 x 1.19	90	7	\$2819	N/A	\$256
GRCD5MTPV	60 x 42 x 1.19	88	7	\$2955	N/A	\$271
GRCD5HMTPV	66 x 42 x 1.19	97	7.5	\$3093	N/A	\$282
GRCD6MTPV	72 x 42 x 1.19	107	8	\$3229	N/A	\$292



Racetrack Tops

Tops feature metal inserts for ease of assembly to base. One dual column base (**GDCB36H28**) required. Limited cut-out options available for power modules, include E2 or FOG2 only. Power modules corresponding to applicable cut-out codes ordered separately.

Required specifications	Optional specifications	Applicable bases	Accessories
Top finish Edge finish ⁽¹⁾	Knife edge ⁽²⁾ 3" radiused corners ⁽⁴⁾ Grommet position or power block cut-out	GDCB36H28	Power block

S SWAP™ TABLES

BOAT SHAPE TOPS FOR DUAL COLUMN BASE

MODEL # DIMENSIONS WT/LB. CUBIC FT. LIST PRICE KS ADD

W x D x H

High pressure laminate, flat edge

GBTD5TP (HP)	60 x 36 x 1	60	6.6	\$678	N/A
GBTD5HTP (HP)	66 x 36 x 1	69	7.21	\$687	N/A
GBTD6TP (HP)	72 x 36 x 1	75	7.82	\$687	N/A
GBTD5MTP (HP)	60 x 42 x 1	73	7.62	\$906	N/A
GBTD5HMTP (HP)	66 x 42 x 1	81	8.32	\$969	N/A
GBTD6MTP (HP)	72 x 42 x 1	89	9.02	\$994	N/A

High pressure laminate, knife edge

GBTD5TPLK	60 x 36 x 1.19	72	6	\$1995	N/A
GBTD5HTPLK	66 x 36 x 1.19	83	6.5	\$2123	N/A
GBTD6TPLK	72 x 36 x 1.19	90	7	\$2251	N/A
GBTD5MTPLK	60 x 42 x 1.19	88	7	\$2379	N/A
GBTD5HMTPLK	66 x 42 x 1.19	97	7.5	\$2507	N/A
GBTD6MTPLK	72 x 42 x 1.19	107	8	\$2635	N/A

Veneer ⁽²⁾

GBTD5TPV	60 x 36 x 1.19	72	6	\$2546	\$230
GBTD5HTPV	66 x 36 x 1.19	83	6.5	\$2682	\$241
GBTD6TPV	72 x 36 x 1.19	90	7	\$2819	\$256
GBTD5MTPV	60 x 42 x 1.19	88	7	\$2955	\$271
GBTD5HMTPV	66 x 42 x 1.19	97	7.5	\$3093	\$282
GBTD6MTPV	72 x 42 x 1.19	107	8	\$3229	\$292

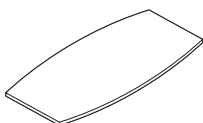

Boat Shape Tops

Tops feature metal inserts for ease of assembly to base. One dual column base (**GDCB36H28**) required.

Limited cut-out options available for power modules, include E2 or FOG2 only. Power modules corresponding to applicable cut-out codes ordered separately.

- GBTDxTP/GBTDxHTP: 36"D at center and 28"D at ends
- GBTDxMTP/GBTDxHMTP: 42"D at center and 33"D at ends.

DUAL COLUMN BASE FOR GxTDxxx TOPS

MODEL # DIMENSIONS WT/LB. CUBIC FT. LIST PRICE BCH / CHM ACO / SBR

W x D x H

BASE VALID FOR TOPS ON PAGES 35-36:

GDCB36H28	19 x 36 x 28	116.23	12.16	\$2103	\$582	\$768
-----------	--------------	--------	-------	---------------	--------------	--------------

seated height

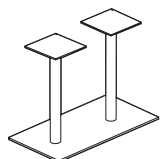

28"H Dual Column Base

Base ships knocked-down; assembly required. Features 0.5" adjustable glides to level on uneven surfaces. Screws included with base for attaching to appropriate top(s). Available in paint and plated finishes as listed on page 18. Upcharge applies on plated finishes.

Required specifications

Top finish
Edge finish ⁽¹⁾
Base finish

Optional specifications

Knife edge ⁽²⁾
Grommet position or power block cut-out
Base plated finish

Applicable bases

GDCB36H28

Accessories

Power block

HUDDLE TABLES OVERVIEW

Bring teams together to huddle, share and collaborate.

Three heights available - seated desk height: 29", counter height: 36", bar height: 41.5" with D top, wedge, rectangular or soft ellipse shaped tops.

Laminate kits (consisting of laminate top and U-base) are sold separately from metal bases for huddle tables. Tops include metal inserts for ease of assembly to metal base. All tops are standard with an edge scoop to help manage cables from wall mounted flat screen monitors and/or edge mounting power module (PS305057/PS305002 as an example). Support channels are included with tops over 60" wide.

Metal bases ship fully assembled and include 0.5" adjustable glides and metal screws for attaching to the top. Be sure to specify bases specific to huddle tables GRHB22Hxx or GSB19Hxx.

D-TOP HUDDLE TABLES

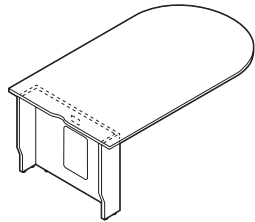

29"H D-Top Huddle

MODEL #	DIMENSIONS	WT/LB.	CUBIC FT.	LIST PRICE
W x D x H				
GDH426029 (HP)	42 x 60 x 29	99.82	5.18	\$1574
GDH427229 (HP)	42 x 72 x 29	111.5	5.79	\$1759
GDH428429 (HP)	42 x 84 x 29	123.1	11.98	\$2093
GDH429629 (HP)	42 x 96 x 29	134.74	13.31	\$2250
GDH486029 (HP)	48 x 60 x 29	112.6	5.89	\$1827
GDH487229 (HP)	48 x 72 x 29	126	6.58	\$2069
GDH488429 (HP)	48 x 84 x 29	139.24	13.5	\$2207
GDH489629 (HP)	48 x 96 x 29	152.56	15	\$2392

Laminate U-base support is 8"D with 7" inside clearance to wall. Access wall through 14.5"H x 9.5"W hinged door with touch latch in front panel of u-base support. U-base includes 0.5" adjustable glides. U-base side panels are tapered at the bottom to clear most baseboards. **Cut-out locations available in positions 1 or 2 only (except for model GDH364829 - cut-out position available in position 1 only).**

- Metal bases sold separately. Compatible with **GRHB22H28** or **GSHB19H28** only, requires one base.

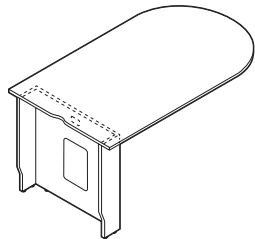

36"H D-Top Huddle

GDH426036 (HP)	42 x 60 x 36	109.82	5.61	\$1605
GDH427236 (HP)	42 x 72 x 36	121.5	6.22	\$1791
GDH428436 (HP)	42 x 84 x 36	133.1	12.4	\$2123
GDH429636 (HP)	42 x 96 x 36	144.74	13.75	\$2281
GDH486036 (HP)	48 x 60 x 36	123.6	6.38	\$1862
GDH487236 (HP)	48 x 72 x 36	137	7.08	\$2104
GDH488436 (HP)	48 x 84 x 36	150.24	14	\$2242
GDH489636 (HP)	48 x 96 x 36	163.56	15.5	\$2428

Laminate U-base support is 8"D with 7" inside clearance to wall. Access wall through 14.5"H x 9.5"W hinged door with touch latch in front panel of U-base support. U-base includes 0.5" adjustable glides. U-base side panels are tapered at the bottom to clear most baseboards. **Cut-out locations available in positions 1 or 2 only (except for model GDH364836 - cut-out position available in position 1 only).**

- Metal bases sold separately. Compatible with **GRHB22H35** or **GSHB19H35** only, requires one base.

Required Specifications

Top finish
Base finish

Optional Specifications

Grommet position or power block cut-out

Accessories

Power block

S SWAP™ TABLES

D-TOP HUDDLE TABLES

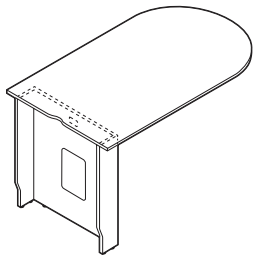

41.5"H D-Top Huddle

MODEL #	DIMENSIONS	WT/LB.	CUBIC FT.	LIST PRICE
---------	------------	--------	-----------	------------

W x D x H

GDH426041 (HP)	42 x 60 x 41.5	117.32	5.92	\$1665
GDH427241 (HP)	42 x 72 x 41.5	129	6.53	\$1849
GDH428441 (HP)	42 x 84 x 41.5	140.6	12.72	\$2183
GDH429641 (HP)	42 x 96 x 41.5	152.24	14.06	\$2341
GDH486041 (HP)	48 x 60 x 41.5	130.1	6.74	\$1552
GDH487241 (HP)	48 x 72 x 41.5	143.5	7.43	\$2169
GDH488441 (HP)	48 x 84 x 41.5	156.74	14.53	\$2308
GDH489641 (HP)	48 x 96 x 41.5	170.06	15.85	\$2492

Laminate U-base support is 8"D with 7" inside clearance to wall. Access wall through 14.5"H x 9.5"W hinged door with touch latch in front panel of U-base support. U-base includes 0.5" adjustable glides. U-base side panels are tapered at the bottom to clear most baseboards. **Cut-out locations available in positions 1 or 2 only (except for model GDH364841 - cut-out position available in position 1 only).**

- Metal bases sold separately. Compatible with **GRHB22H41** or **GSHB19H41** only, requires one base.

Required Specifications

Top finish
Base finish

Optional Specifications

Grommet position or power block cut-out

Accessories

Power block

WEDGE HUDDLE TABLES **MODEL #** **DIMENSIONS** **WT/LB.** **CUBIC FT.** **LIST PRICE**

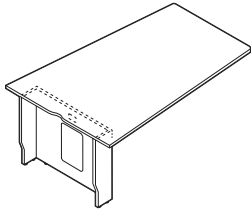

29"H Wedge Huddle

	W x D x H			
GWH486029 (HP)	48 x 60 x 29	112.6	5.89	\$1822
GWH487229 (HP)	48 x 72 x 29	126	6.58	\$2069
GWH488429 (HP)	48 x 84 x 29	139.24	13.5	\$2207
GWH489629 (HP)	48 x 96 x 29	152.56	15	\$2392

Laminate U-base support is 8"D with 7" inside clearance to wall. Access wall through 14.5"H x 9.5"W hinged door with touch latch in front panel of U-base support. U-base includes 0.5" adjustable glides. U-base side panels are tapered at the bottom to clear most baseboards. **Cut-out locations available in positions 1 or 2 only.**

- Metal bases sold separately. Compatible with **GRHB22H28** or **GSHB19H28** only, requires one base.

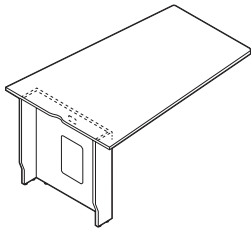

36"H Wedge Huddle

GWH486036 (HP)	48 x 60 x 36	123.6	6.38	\$1857
GWH487236 (HP)	48 x 72 x 36	137	7.08	\$2104
GWH488436 (HP)	48 x 84 x 36	150.24	14	\$2242
GWH489636 (HP)	48 x 96 x 36	163.56	15.5	\$2428

Laminate U-base support is 8"D with 7" inside clearance to wall. Access wall through 14.5"H x 9.5"W hinged door with touch latch in front panel of U-base support. U-base includes 0.5" adjustable glides. U-base side panels are tapered at the bottom to clear most baseboards. **Cut-out locations available in positions 1 or 2 only.**

- Metal bases sold separately. Compatible with **GRHB22H35** or **GSHB19H35** only, requires one base.

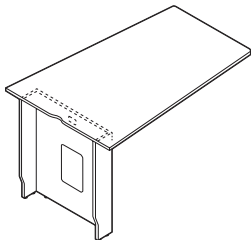

41.5"H Wedge Huddle

GWH486041 (HP)	48 x 60 x 41.5	130.1	6.74	\$1922
GWH487241 (HP)	48 x 72 x 41.5	143.5	7.43	\$2169
GWH488441 (HP)	48 x 84 x 41.5	156.74	14.35	\$2308
GWH489641 (HP)	48 x 96 x 41.5	170.06	15.85	\$2492

Laminate U-base support is 8"D with 7" inside clearance to wall. Access wall through 14.5"H x 9.5"W hinged door with touch latch in front panel of U-base support. U-base includes 0.5" adjustable glides. U-base side panels are tapered at the bottom to clear most baseboards. **Cut-out locations available in positions 1 or 2 only.**

- Metal bases sold separately. Compatible with **GRHB22H41** or **GSHB19H41** only, requires one base.

Required Specifications

Top finish
Base finish

Optional Specifications

Grommet position or power block cut-out

Accessories

Power block

S SWAP™ TABLES

RECTANGULAR HUDDLE TABLES

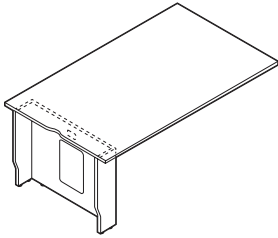

29"H Rectangular Huddle

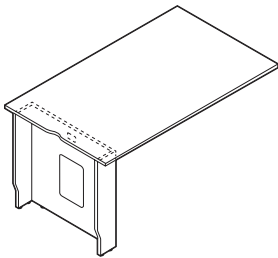

36"H Rectangular Huddle

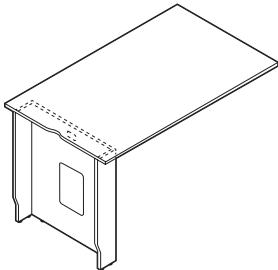

41.5"H Rectangular Huddle

MODEL #	DIMENSIONS	WT/LB.	CUBIC FT.	LIST PRICE
---------	------------	--------	-----------	------------

W x D x H

GRH426029 (HP)	42 x 60 x 29	99.82	5.18	\$1574
GRH427229 (HP)	42 x 72 x 29	111.5	5.79	\$1759
GRH428429 (HP)	42 x 84 x 29	123.1	11.98	\$2093
GRH429629 (HP)	42 x 96 x 29	134.74	13.31	\$2250

GRH486029 (HP)	48 x 60 x 29	112.6	5.89	\$1827
GRH487229 (HP)	48 x 72 x 29	126	6.58	\$2069
GRH488429 (HP)	48 x 84 x 29	139.24	13.5	\$2207
GRH489629 (HP)	48 x 96 x 29	152.56	15	\$2392

Laminate u-base support is 8"D with 7" inside clearance to wall. Access wall through 14.5"H x 9.5"W hinged door with touch latch in front panel of u-base support. U-base includes 0.5" adjustable glides. U-base side panels are tapered at the bottom to clear most baseboards. **Cut-out locations available in positions 1 or 2 only (except for model GRH364829 - cut-out position available in position 1 only).**

- Metal bases sold separately. Compatible with **GRHB22H28** or **GSHB19H28** only, requires one base.

GRH426036 (HP)	42 x 60 x 36	109.82	5.61	\$1605
GRH427236 (HP)	42 x 72 x 36	121.5	6.22	\$1791
GRH428436 (HP)	42 x 84 x 36	133.1	12.41	\$2123
GRH429636 (HP)	42 x 96 x 36	144.74	13.75	\$2281

GRH486036 (HP)	48 x 60 x 36	123.6	6.38	\$1862
GRH487236 (HP)	48 x 72 x 36	137	7.08	\$2104
GRH488436 (HP)	48 x 84 x 36	150.24	14	\$2242
GRH489636 (HP)	48 x 96 x 36	163.56	15.5	\$2428

Laminate u-base support is 8"D with 7" inside clearance to wall. Access wall through 14.5"H x 9.5"W hinged door with touch latch in front panel of u-base support. U-base includes 0.5" adjustable glides. U-base side panels are tapered at the bottom to clear most baseboards. **Cut-out locations available in positions 1 or 2 only (except for model GRH364836 - cut-out position available in position 1 only).**

- Metal bases sold separately. Compatible with **GRHB22H35** or **GSHB19H35** only, requires one base.

GRH426041 (HP)	42 x 60 x 41.5	117.32	5.92	\$1665
GRH427241 (HP)	42 x 72 x 41.5	129	6.53	\$1849
GRH428441 (HP)	42 x 84 x 41.5	140.6	12.72	\$2183
GRH429641 (HP)	42 x 96 x 41.5	152.24	14.06	\$2341

GRH486041 (HP)	48 x 60 x 41.5	130.1	6.74	\$1926
GRH487241 (HP)	48 x 72 x 41.5	143.5	7.43	\$2169
GRH488441 (HP)	48 x 84 x 41.5	156.74	14.35	\$2308
GRH489641 (HP)	48 x 96 x 41.5	170.06	15.85	\$2492

Laminate U-base support is 8"D with 7" inside clearance to wall. Access wall through 14.5"H x 9.5"W hinged door with touch latch in front panel of U-base support. U-base includes 0.5" adjustable glides. U-base side panels are tapered at the bottom to clear most baseboards. **Cut-out locations available in positions 1 or 2 only (except for model GRH364841 - cut-out position available in position 1 only).**

- Metal bases sold separately. Compatible with **GRHB22H41** or **GSHB19H41** only, requires one base.

Required Specifications

Top finish
Base finish

Optional Specifications

Grommet position or power block cut-out

Accessories

Power block

SOFT ELLIPSE HUDDLE TABLES

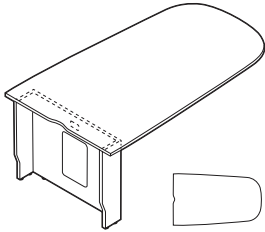

29"H Soft Ellipse Huddle

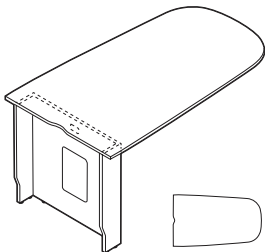

36"H Soft Ellipse Huddle

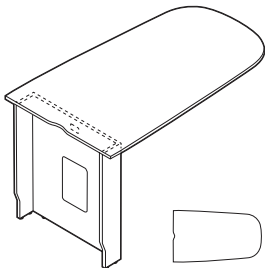

41.5"H Soft Ellipse Huddle

MODEL # DIMENSIONS WT/LB. CUBIC FT. LIST PRICE

W x D x H

GSEH426029 (HP)	42 x 60 x 29	99.82	5.18	\$1574
GSEH427229 (HP)	42 x 72 x 29	111.5	5.79	\$1759
GSEH428429 (HP)	42 x 84 x 29	123.1	11.98	\$2093
GSEH429629 (HP)	42 x 96 x 29	134.7	13.31	\$2250

GSEH486029 (HP)	48 x 60 x 29	112.6	5.89	\$1827
GSEH487229 (HP)	48 x 72 x 29	126	6.58	\$2069
GSEH488429 (HP)	48 x 84 x 29	139.2	13.5	\$2207
GSEH489629 (HP)	48 x 96 x 29	152.6	15	\$2392

Laminate u-base support is 8"D with 7" inside clearance to wall. Access wall through 14.5"H x 9.5"W hinged door with touch latch in front panel of u-base support. U-base includes 0.5" adjustable glides. U-base side panels are tapered at the bottom to clear most baseboards. **Cut-out locations available in positions 1 or 2 only (except for model GSEH364829 - cut-out position available in position 1 only).**

- Metal bases sold separately. Compatible with **GRHB22H28** or **GSHB19H28** only, requires one base.

GSEH426036 (HP)	42 x 60 x 36	109.8	5.61	\$1605
GSEH427236 (HP)	42 x 72 x 36	121.5	6.22	\$1791
GSEH428436 (HP)	42 x 84 x 36	133.1	12.41	\$2123
GSEH429636 (HP)	42 x 96 x 36	144.74	13.75	\$2281

GSEH486036 (HP)	48 x 60 x 36	123.6	6.38	\$1862
GSEH487236 (HP)	48 x 72 x 36	137	7.08	\$2104
GSEH488436 (HP)	48 x 84 x 36	150.24	14	\$2242
GSEH489636 (HP)	48 x 96 x 36	163.56	15.5	\$2428

Laminate u-base support is 8"D with 7" inside clearance to wall. Access wall through 14.5"H x 9.5"W hinged door with touch latch in front panel of u-base support. U-base includes 0.5" adjustable glides. U-base side panels are tapered at the bottom to clear most baseboards. **Cut-out locations available in positions 1 or 2 only (except for model GSEH364836 - cut-out position available in position 1 only).**

- Metal bases sold separately. Compatible with **GRHB22H35** or **GSHB19H35** only, requires one base.

GSEH426041 (HP)	42 x 60 x 41.5	117.32	5.92	\$1665
GSEH427241 (HP)	42 x 72 x 41.5	129	6.53	\$1849
GSEH428441 (HP)	42 x 84 x 41.5	140.6	12.72	\$2183
GSEH429641 (HP)	42 x 96 x 41.5	152.24	14.06	\$2341

GSEH486041 (HP)	48 x 60 x 41.5	130.1	6.74	\$1926
GSEH487241 (HP)	48 x 72 x 41.5	143.5	7.43	\$2169
GSEH488441 (HP)	48 x 84 x 41.5	156.74	14.35	\$2308
GSEH489641 (HP)	48 x 96 x 41.5	170.06	15.85	\$2492

Laminate u-base support is 8"D with 7" inside clearance to wall. Access wall through 14.5"H x 9.5"W hinged door with touch latch in front panel of u-base support. U-base includes 0.5" adjustable glides. U-base side panels are tapered at the bottom to clear most baseboards. **Cut-out locations available in positions 1 or 2 only (except for model GSEH364841 - cut-out position available in position 1 only).**

- Metal bases sold separately. Compatible with **GRHB22H41** or **GSHB19H41** only, requires one base.

Required Specifications

Top finish
Base finish

Optional Specifications

Grommet position or power block cut-out

Accessories

Power block

HUDDLE BASES **MODEL #** **DIMENSIONS** **WT/LB.** **CUBIC FT.** **LIST PRICE** **BCH / CHM** **ACO / SBR**

W x D x H

SELECT BASE COMPATIBLE WITH TOP HEIGHT:

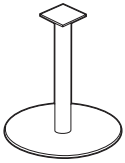

22" Round Huddle Base

GRHB22H28	22 x - x 28	60	10	\$898	\$147	\$249
GRHB22H35	22 x - x 35	62	12.7	\$933	\$164	\$268
GRHB22H41	22 x - x 40.5	63	14.2	\$949	\$171	\$270

GRHB22H35 - counter height **GRHB22H28** - seated height **GRHB22H41** - bar height

Metal base ships fully assembled. Features 0.5" adjustable glides to level on uneven surfaces. Screws included with base for attaching to appropriate huddle table laminate pieces. See page 18 for available finishes.

Be sure to double check huddle table laminate units and metal bases are the same corresponding heights.

- Plated finishes are available at an upcharge.

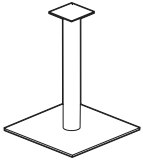

18.5" Square Huddle Base

GSHB19H28	18.5 x 18.5 x 28	55	6.94	\$966	\$136	\$250
GSHB19H35	18.5 x 18.5 x 35	57	8.8	\$1022	\$151	\$287
GSHB19H41	18.5 x 18.5 x 40.5	58	9.84	\$1056	\$166	\$287

GSHB19H35 - counter height **GSHB19H28** - seated height **GSHB19H41** - bar height

Metal base ships fully assembled. Features 0.5" adjustable glides to level on uneven surfaces. Screws included with base for attaching to appropriate huddle table laminate pieces. See page 18 for available finishes.

Be sure to double check huddle table laminate units and metal bases are the same corresponding heights.

- Plated finishes are available at an upcharge.

Required Specifications

Finish

Optional Specifications

tables training



Bungee

44



Junction

56





Bungee is a series of freestanding tables and accessories designed for classrooms, training rooms, boardrooms and any other multi-functional space that may require frequent configurations. Tables are sold complete with legs and Bungee cords so they may quickly and easily be connected together without searching for tools or worrying about loose parts.

Bungee tables feature optional rounded corners with a unique Bubble molding that is engineered to compress under the tension of the Bungee cords. The compressed molding creates a seal that serves to locate and align interconnected tables while also providing a soft and forgiving edge. Four additional edge options are available.

Choose from a variety of top shapes and laminate finishes to create your individual style. In addition, most tables offer a choice of tapered legs or spider legs in a Black or Tungsten finish with adjustable levelers or optional casters. Optional modesty panels, grommets, wire management and power blocks further enhance your workspace.

Features and Benefits

- Bungee tables are complete with top, legs and Bungee cords.
- Bungee cords provide a fast and easy method of reconfiguring tables without requiring tools.
- Tops are 1" thick and are offered in a variety of shapes and sizes.
- Legs are offered in tapered or spider design in a Black or Tungsten finish.
- Levelers on legs are standard.
- Laminate modesty panels and filler modesty inserts help conceal wires and enhance visual appeal.
- Wire management tracks neatly contain wires, using two separate channels for data and voice wires.
- Optional grommets or power blocks offer technological flexibility.

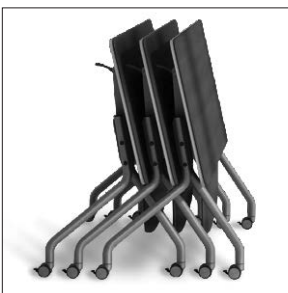

Flip-top tables can be nested and easily stored by activating the single hand release mechanism from the left or right side.

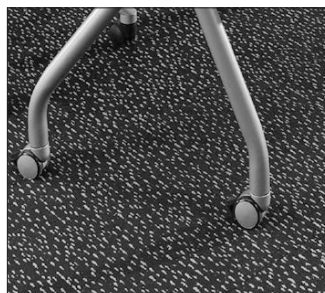

Optional locking casters are available in Black or Tungsten finish (standard on flip-top models).

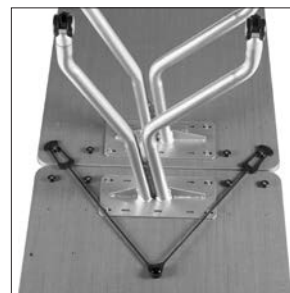

Bungee cords are utilized to quickly and easily reconfigure tables.

GENERAL INFORMATION

- Bungee is a series of freestanding tables and accessories designed for classrooms, training rooms, boardrooms and any other multifunctional space that requires frequent reconfigurations.
- Bungee tables come complete with a work top, a set of legs and built-in Bungee cord connectors.
- Bungee cords allow the movement and reconfiguration of tables without a risk of damage or losing loose parts.
- High pressure tops are standard in all Bungee laminate finishes.
- Unique “bubble molding” edging is specially engineered to create a secure seal to align interconnected tables. Alternate edge options are also available.
- Bungee products have been tested and comply with all mechanical tests.
- For environmental certifications, please visit globalfurnituregroup.com.

CONSTRUCTION

- Tops are 1” thick. Modesty panels are 11/16” thick.
- All components are made of 45 lb. commercial density particle board, covered on both sides with high performance laminate.
- Tops 54” and over feature a built-in support bar.

BUNGEE CORDS

- Bungee cords are patented elastic devices designed to provide a rapid, no-tool method of attaching tables of the same depth.
- The elastic nature of cords allows two connected tables to be moved around without risk of damage to the table top or connecting hardware.
- Bungee cords are included with all freestanding tables and carry a Lifetime Warranty.

EDGE DETAIL

- Unique “bubble molding” is engineered to compress under the tension of the Bungee cords, creating a seal that serves to locate and align interconnected tables.
- Bubble molding finish matches surface laminate with Silver (**BS**) or Black (**BB**) accent trim.
- For matching 2mm flat edge, specify (**A3**).

LEGS

- Tables feature two styles of legs - tapered leg and spider leg. Available in Black (**TBL**) or Tungsten (**TTU**) finish.
- Levelers are standard. Optional locking casters are available at no upcharge, specify Black (**TBC**) or Tungsten (**TTC**) finish. (Casters must match base finish.) Adjust 3mm - 10mm in height.



tapered leg



spider leg

MODESTY PANELS

- Panels are 13” high, recessed 0.75” from the back and inset 7” from the sides.
- Panels feature a built-in flexible wire pass-through.
- Available in all Bungee laminate finishes.

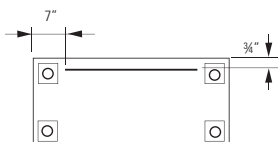
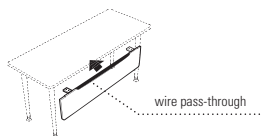

FILLER MODESTY PANELS

- Used to fill the space between two modesty panels when two tables are linked together. Helps conceal wires and enhance visual appeal.
- Available in Silver finish (**SI**) or Black finish (**BK**), please specify.

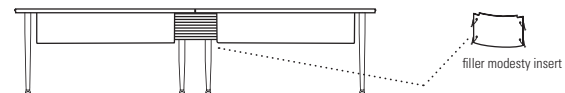

WIRE MANAGEMENT

- Wire management tracks are mounted to the underside of the worksurface. Available in 5” and 22” track lengths.
- 5” track includes one wire clamp; 22” track includes two wire clamps.
- Data and voice wires can be routed separately using two separate channels on each clamp.
- Available in Black only.

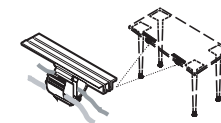

5” wire management track

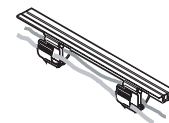

22” wire management track

B BUNGEE™ TABLES - HOW TO SPECIFY

1. SPECIFY MODEL NUMBER

2. SPECIFY FINISH

Laminate Finishes:

ACJ Absolute Acajou	FCL First Class
ASN Asian Night	NBL Noce Biondo
AWC Avant Cherry	NGL Noce Grigio
AWH Avant Honey	NEL Noce Leggero
BLK Black	NML Noce Medio
BZD Blizzard	QTM Quartered Mahogany
BRC Brushed Cobalt	SBY Sheer Beauty
CMB Clear Maple	SDT Stonedust
CGY Custom Grey	SOG Storm Grey
DES Dark Espresso	WHE Walnut Heights
DWT Designer White	WHC White Chocolate
FAS Fashionista	WCR Winter Cherry

Edge:

BB Bubble edge with Black trim
BS Bubble edge with Silver trim
A3 Matching 2mm flat edge

Legs:

TBL Black
TTU Tungsten

Casters:

TBC Black
TTC Tungsten

Handles:

HS Silver finish
HT Black finish

Modesty Panel Edge:

SI Silver
BK Black Nickel

Feet

TBL Black	TTU Tungsten
------------------	---------------------

3. SPECIFY OPTIONS

GROMMETS

- Optional grommets available in standard worksurface locations (left, center or right) for **rectangular tops** (48" wide and up). Order as: **FOG1, FOG2 or FOG3. Add \$91.**
- Optional grommets are available in **center position only** for **rectangular tops** (36" and 42" wide), **trapezoid tables** and **ALL flip-top and transformer tables**. Order as **FOG2. Add \$91** per table.
- FOG2** when selected will apply to all 4 or 6 tables in transformer table kits accordingly.
- Grommet hole dimensions are 3.25" wide x 1.875" deep.
- Grommets may be placed at non-standard locations. Order as: **CSG. Add \$132.** A drawing must be supplied with vertical and horizontal dimensions to the center of the cut-out (as in drawing above). Please refer to the **custom grommet location form** in the back reference section.

Grommet hole dimensions

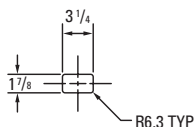

Grommet

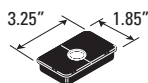

Rectangular Tops

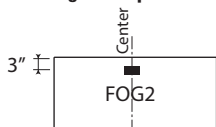

For 36", 42" and 48" wide units

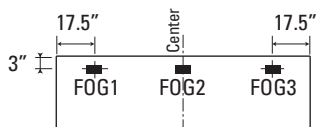

For 60" and 72" wide units

Trapezoid Tables and all Flip-Top Tables

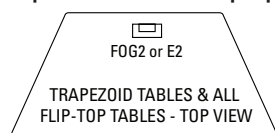

grommet location
FOG2. Add \$91.

Transformer Tables

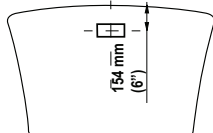

grommet location
FOG2. Add \$91 x number of tables in kit

MODPOWER DAISY-CHAIN SOLUTION

- Add flexible power and USB charging to Bungee **rectangular tables**. Connect up to four units with a single corded infeed with NEMA plug.
- ModPower units are sold separately, refer to Productivity Solutions page 88.
- Begin run with a starter unit which includes a corded infeed. Add additional middle or end units as required. Middle and end units are equipped with connecting cables.
- On-surface modules clamp on or screw mount to the table tops.
- In-surface modules require table top cut-outs for mounting. Specify cut-out option:
 - MPS** for a single cut-out to accommodate one ModPower in-surface unit (cut-out will be centered on the approach side) for **42" to 72" wide fixed top** rectangular tables and **48" to 72" wide flip-top** rectangular tables. Add **\$91**. Note: MPS not available for 36" wide fixed top tables or 42" wide flip-top tables.
 - MPD** for two cut-outs in the left and right positions, 18.25" from ends to center of unit on approach side for **60", 66" and 72" wide rectangular tables**. Add **\$183**.

SPECIFICATIONS

- Specifications marked with an * are applicable to only those products which have the * symbol beside the product name.

CONNECTING CONDITIONS

- Bungee cords allow for fast and easy reconfiguring of tables whenever needed. Due to the elastic nature of the Bungee cord, two tables connected with Bungee cords can be moved around without risk of damage to the table top or the connecting hardware.
- Connecting tables is simple and intuitive. Tools are not required and there are no loose parts that may be misplaced.
- Bungee cords connect tables of the same depth in all directions.
- Rectangular tables 48" and longer connect in both straight and "L" configurations. Rectangular tables 36" and 42" connect in straight configurations only.

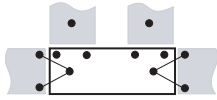
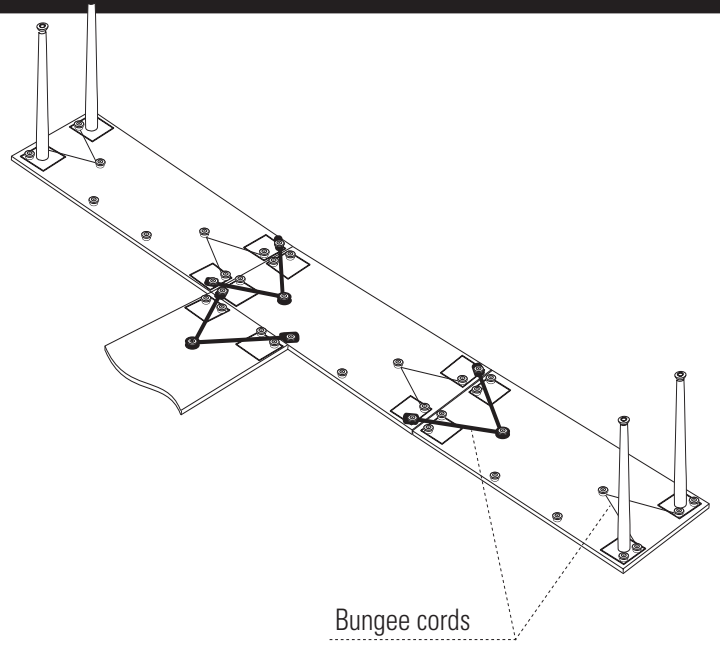

rectangular tables



round wedge tables

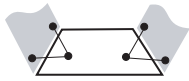

trapezoid tables

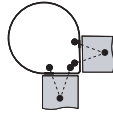

teardrop tables

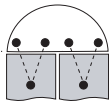

half moon tables

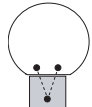

flat round tables

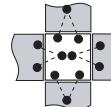

square tables



keystone tables

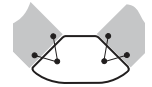

wedge tables

FLIP-TOP TABLE NESTING DIAGRAM

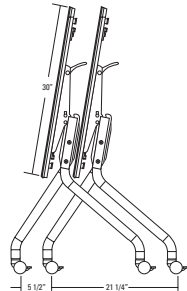
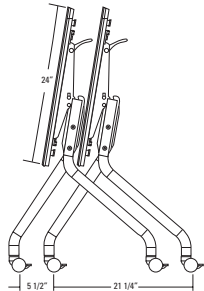

B BUNGEE™ TABLES

RECTANGULAR TABLES

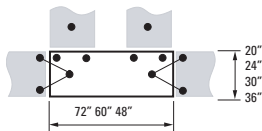
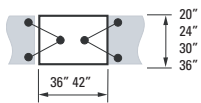

Rectangular Table - Tapered Legs

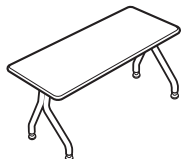
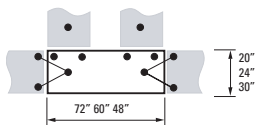
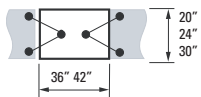

Rectangular Table - Spider Legs

MODEL #	DIMENSIONS	WT/LB.	CUBIC FT.	LIST PRICE
---------	------------	--------	-----------	------------

W x D x H

B2436REF (HP)	36 x 24 x 28.7	65	5.75	\$931
B2442REF (HP)	42 x 24 x 28.7	69	6	\$1015
B2448REF (HP)	48 x 24 x 28.7	72	6.5	\$1039
B2460REF (HP)	60 x 24 x 28.7	82	7.25	\$1277
B2472REF (HP)	72 x 24 x 28.7	91	8	\$1547

B3036REF (HP)	36 x 30 x 28.7	70	7.25	\$1074
B3042REF (HP)	42 x 30 x 28.7	78	7.5	\$1141
B3048REF (HP)	48 x 30 x 28.7	81	7.5	\$1199
B3060REF (HP)	60 x 30 x 28.7	92	8.25	\$1324
B3072REF (HP)	72 x 30 x 28.7	102	9	\$1560

B3642REF (HP)	42 x 36 x 28.7	83	7.5	\$1209
B3648REF (HP)	48 x 36 x 28.7	91	8	\$1304
B3660REF (HP)	60 x 36 x 28.7	103	9	\$1419
B3672REF (HP)	72 x 36 x 28.7	116	10	\$1686

Freestanding table includes four tapered legs with levelers and Bungee cords. When **(BB)** or **(BS)** edge option is specified, surface corners are radiused; when **(A3)** edge option is specified, surface corners are square. Each table can be "Bungee-tied" to other tables of the same depth. Shipped easy to assemble in 2 cartons. Modesty panels available, see page 52.

- **Tables 48" and longer connect in both straight and "L" configurations.**
- **Tables 36" and 42" connect in straight configurations only.**
- Available with optional locking casters, specify Black **(TBC)** or Tungsten **(TTC)**.

B2436RES (HP)	36 x 24 x 28.7	62	7.25	\$1026
B2442RES (HP)	42 x 24 x 28.7	67	7.5	\$1107
B2448RES (HP)	48 x 24 x 28.7	71	10	\$1138
B2460RES (HP)	60 x 24 x 28.7	80	10.75	\$1372
B2472RES (HP)	72 x 24 x 28.7	89	11.25	\$1646

B3036RES (HP)	36 x 30 x 28.7	72	10.25	\$1198
B3042RES (HP)	42 x 30 x 28.7	80	10.5	\$1261
B3048RES (HP)	48 x 30 x 28.7	83	10.5	\$1324
B3060RES (HP)	60 x 30 x 28.7	94	11.25	\$1449
B3072RES (HP)	72 x 30 x 28.7	104	12	\$1672

Freestanding table includes two spider legs with levelers and Bungee cords. When **(BB)** or **(BS)** edge option is specified, surface corners are radiused; when **(A3)** edge option is specified, surface corners are square. Each table can be "Bungee-tied" to other tables of the same depth. Shipped easy to assemble in 2 cartons. Modesty panels available, see page 52.

- **Tables 48" and longer connect in both straight and "L" configurations.**
- **Tables 36" and 42" connect in straight configurations only.**
- Available with optional locking casters, specify Black **(TBC)** or Tungsten **(TTC)**.

Required specifications

Top finish
Edge detail
Leg finish

Optional specifications

Casters
Grommet
Power block cut-out

Accessories

Power block

TRAPEZOID TABLES **MODEL #** **DIMENSIONS** **WT/LB.** **CUBIC FT.** **LIST PRICE**

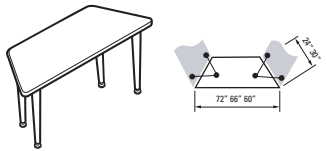

Trapezoid Table - Tapered Legs

W x D x H

B2460TRF (HP)	60 x 24 x 28.7	71	7.5	\$1209
B2466TRF (HP)	66 x 24 x 28.7	74	8	\$1408
B2472TRF (HP)	72 x 24 x 28.7	78	8.25	\$1479
B3060TRF (HP)	60 x 30 x 28.7	78	8.5	\$1312
B3066TRF (HP)	66 x 30 x 28.7	81	9.5	\$1492
B3072TRF (HP)	72 x 30 x 28.7	85	9.5	\$1547

Freestanding table includes four tapered legs with levelers and Bungee cords. Bubble edge options **(BB)** or **(BS)** only apply (edge option **(A3)** is not applicable on trapezoid tables). Each table can be “Bungee-tied” to other tables of the same depth. Shipped easy to assemble in 2 cartons. Modesty panels available, see page 52.

- Available with optional locking casters, specify Black **(TBC)** or Tungsten **(TTC)**.

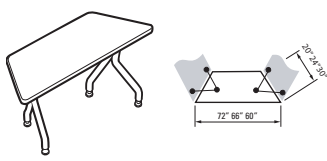

Trapezoid Table - Spider Legs

B2460TRS (HP)	60 x 24 x 28.7	69	9.25	\$1304
B2466TRS (HP)	66 x 24 x 28.7	72	9.75	\$1532
B2472TRS (HP)	72 x 24 x 28.7	76	10	\$1574
B3060TRS (HP)	60 x 30 x 28.7	79	11.5	\$1424
B3066TRS (HP)	66 x 30 x 28.7	83	12.5	\$1605
B3072TRS (HP)	72 x 30 x 28.7	87	12.5	\$1661

Freestanding table includes two spider legs with levelers and Bungee cords. Bubble edge options **(BB)** or **(BS)** only apply (edge option **(A3)** is not applicable on trapezoid tables). Each table can be “Bungee-tied” to other tables of the same depth. Shipped easy to assemble in 2 cartons. Modesty panels available, see page 52.

- Available with optional locking casters, specify Black **(TBC)** or Tungsten **(TTC)**.

KEYSTONE TABLES

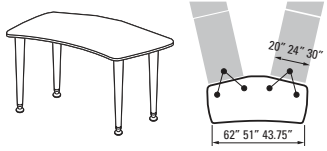

Keystone Table - Tapered Legs

B30KSF (HP)	62 x 30 x 28.7	69	7.6	\$1375
B24KSF (HP)	51 x 24 x 28.7	60	6.5	\$1171

Freestanding table includes four tapered legs with levelers and Bungee cords. When **(BB)** or **(BS)** edge option is specified, surface corners are radiused; when **(A3)** edge option is specified, surface corners are square. Each table can be “Bungee-tied” to other tables of 24” and 30” depth. Shipped easy to assemble in 2 cartons. Modesty panels or filler panels are NOT available.

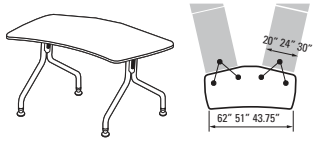

Keystone Table - Spider Legs

B30KSS (HP)	62 x 30 x 28.7	77	7.6	\$1541
B24KSS (HP)	51 x 24 x 28.7	66	6.5	\$1310

Freestanding table includes two spider legs with levelers and Bungee cords. When **(BB)** or **(BS)** edge option is specified, surface corners are radiused; when **(A3)** edge option is specified, surface corners are square. Each table can be “Bungee-tied” to other tables of 24” and 30” depth. Shipped easy to assemble in 2 cartons. Modesty panels or filler panels are NOT available.

Required specifications	Optional specifications	Accessories
Top finish Edge detail Leg finish	Grommet (only trapezoid tables) Casters (only trapezoid tables) Power block cut-out (only trapezoid tables)	Power block (only trapezoid tables)

B BUNGEE™ TABLES

WEDGE TABLES

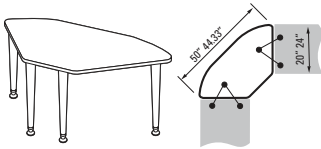

Wedge Table - Tapered Legs

MODEL #	DIMENSIONS	WT/LB.	CUBIC FT.	LIST PRICE
W x D x H				
B24WEF (HP)	63 x 24 x 28.7	54	6.6	\$1208

Freestanding table includes four tapered legs with levelers and Bungee cords. When **(BB)** or **(BS)** edge option is specified, surface corners are radiused; when **(A3)** edge option is specified, surface corners are square. Each table can be "Bungee-tied" to other tables of the same depth. Shipped easy to assemble in 2 cartons. Modesty panels available, see page 52.

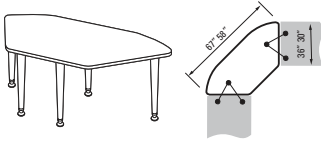

Wedge Table - Tapered Legs

B30WEF (HP)	70 x 30 x 28.7	70	7.2	\$1476
-------------	----------------	----	-----	---------------

Freestanding table includes five tapered legs with levelers and Bungee cords. When **(BB)** or **(BS)** edge option is specified, surface corners are radiused; when **(A3)** edge option is specified, surface corners are square. Each table can be "Bungee-tied" to other tables of the same depth. Shipped easy to assemble in 2 cartons. Modesty panels available, see page 52.

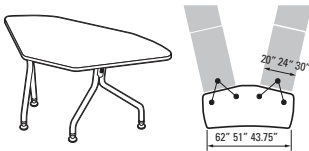

Wedge Table - Spider Legs

B30WES (HP)	70 x 30 x 28.7	73	7.2	\$1463
B24WES (HP)	63 x 24 x 28.7	62	6.6	\$1324

Freestanding table includes two spider legs with levelers and Bungee cords. When **(BB)** or **(BS)** edge option is specified, surface corners are radiused; when **(A3)** edge option is specified, surface corners are square. Each table can be "Bungee-tied" to other tables of the same depth. Shipped easy to assemble in 2 cartons. Modesty panels available, see page 52.

HALF MOON TABLES

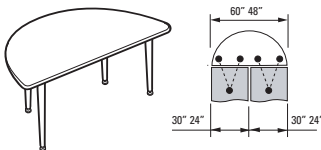

Half Moon Table - Tapered Legs

B2448HMF (HP)	48 x 24 x 28.7	110	7.75	\$966
B3060HMF (HP)	60 x 30 x 28.7	81	8.5	\$1175

Freestanding table includes four tapered legs with levelers and Bungee cords. When **(BB)** or **(BS)** edge option is specified, surface corners are radiused; when **(A3)** edge option is specified, surface corners are square. Each table can be "Bungee-tied" to other tables of the same depth. Shipped easy to assemble in 2 cartons.

Modesty panels or filler panels are NOT available.

- Available with optional locking casters, specify Black **(TBC)** or Tungsten **(TTC)**.

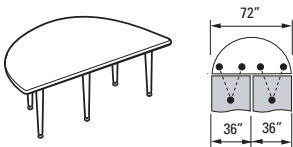

Half Moon Table - Tapered Legs

B3672HMF (HP)	72 x 36 x 28.7	110	11.5	\$1641
---------------	----------------	-----	------	---------------

Freestanding table includes five tapered legs with levelers and Bungee cords. When **(BB)** or **(BS)** edge option is specified, surface corners are radiused; when **(A3)** edge option is specified, surface corners are square. Each table can be "Bungee-tied" to other tables of the same depth. Shipped easy to assemble in 2 cartons.

Modesty panels or filler panels are NOT available.

- Available with optional locking casters, specify Black **(TBC)** or Tungsten **(TTC)**.

Required specifications

Top finish
Edge detail
Leg finish

Optional specifications

Casters (only half moon tables)
Grommet (only half moon tables)

Accessories

Power block (only position 2)

HALF MOON TABLES **MODEL #** **DIMENSIONS** **WT/LB.** **CUBIC FT.** **LIST PRICE**

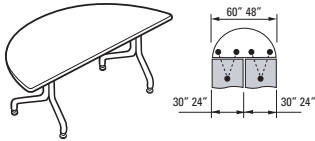

Half Moon Table - Spider Legs*

	W x D x H			
B2448HMS (HP)	48 x 24 x 28.7	67	9.25	\$1070
B3060HMS (HP)	60 x 30 x 28.7	83	11.5	\$1295

Freestanding table includes two spider legs with levelers and Bungee cords. When **(BB)** or **(BS)** edge option is specified, surface corners are radiused; when **(A3)** edge option is specified, surface corners are square. Each table can be "Bungee-tied" to other tables of the same depth. Shipped easy to assemble in 2 cartons. Modesty panels or filler panels are NOT available.

- Available with optional locking casters, specify Black **(TBC)** or Tungsten **(TTC)**.

SQUARE TABLES

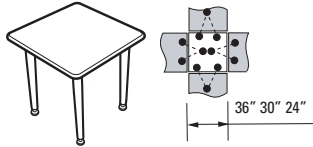

Square Table - Tapered Legs

B3636SQF (HP)	36 x 36 x 28.7	78	8	\$1077
---------------	----------------	----	---	---------------

Freestanding table includes four tapered legs with levelers and Bungee cords. When **(BB)** or **(BS)** edge option is specified, surface corners are radiused; when **(A3)** edge option is specified, surface corners are square. Each table can be "Bungee-tied" to other tables of the same depth. Shipped easy to assemble in 2 cartons. Note: Square tables will NOT accept laminate modesty panels.

- Available with optional locking casters, specify Black **(TBC)** or Tungsten **(TTC)**.

Required specifications

Top finish
Edge detail
Leg finish

Optional specifications

Casters
Grommet*

B BUNGEE™ TABLES

MODESTY PANELS - SQUARE

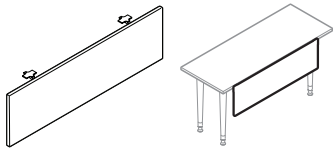

Modesty Panel - Square

MODEL #	DIMENSIONS W x D x H	WT/LB.	CUBIC FT.	LIST PRICE	HP ADD
BX36QMP	21 x 0.69 x 9.6	6	0.9	\$97	N/A
BX42QMP	27 x 0.69 x 9.6	7	1.1	\$101	N/A
BX48QMP	33 x 0.69 x 9.6	9	1.2	\$109	N/A
BX60QMP	45 x 0.69 x 9.6	12	1.6	\$117	N/A
BX66QMP	51 x 0.69 x 9.6	13	1.8	\$123	N/A
BX72QMP	57 x 0.69 x 9.6	14	2	\$127	N/A

For use on **rectangular** tables. Includes hinged mounting bracket.
Available in standard line finishes. Edging only available in Silver (**SI**) or Black (**BK**). Please specify.
• Modesty panel model number indicates the width of table to be used on.

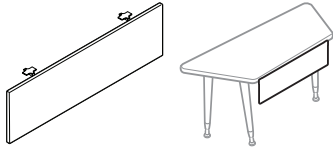

Modesty Panel - Square

BXM60QMP	27 x 0.69 x 9.6	7	1.1	\$101	N/A
BXM66QMP	33 x 0.69 x 9.6	9	1.2	\$109	N/A
BXM72QMP	39 x 0.69 x 9.6	10	1.4	\$113	N/A
BXL60QMP	21 x 0.69 x 9.6	6	0.9	\$98	N/A
BXL66QMP	27 x 0.69 x 9.6	7	1.1	\$101	N/A
BXL72QMP	33 x 0.69 x 9.6	9	1.2	\$109	N/A

For use on **trapezoid** tables. Includes hinged mounting bracket. Intended for use on the short side of the table; may be used on long side but leaves a larger gap.
Available in standard line finishes. Edging only available in Silver (**SI**) or Black (**BK**). Please specify.
• Modesty panel model number indicates the width of table to be used on.
• Specify **BXM** models for 24"D tables and **BXL** models for 30"D tables.

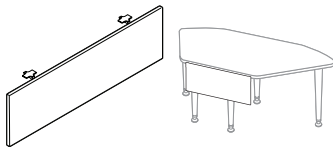

Modesty Panel - Square

BXWQMP	27 x 0.69 x 9.6	7	1.1	\$101	N/A
--------	-----------------	---	-----	--------------	-----

For use on **wedge** tables. Includes hinged mounting bracket. Intended for use on the short side of the table.
Available in standard line finishes. Edging only available in Silver (**SI**) or Black (**BK**). Please specify.

FILLER MODESTY PANELS

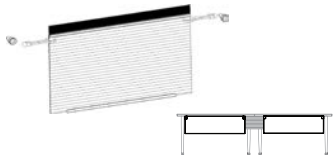

Filler Modesty Panel - Straight

BSFMS	21 x 0.25 x 9	1	0.3	\$98	N/A
-------	---------------	---	-----	-------------	-----

Used to fill the space between two **square** modesty panels where tables are linked in a straight configuration.
Available in Silver (**SI**) or Black (**BK**). Please specify.

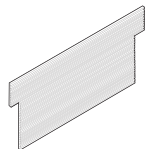

Filler Modesty Panel - Straight to Wedge

BSWFM	19.6 x 9 x 0.25	2	0.1	\$127	N/A
-------	-----------------	---	-----	--------------	-----

Used to fill the space between a straight modesty panel and wedge table.
Use for regular wedge table - tapered legs and flip-top wedge - spider legs.

Required specifications

Finish

WIRE MANAGEMENT MODEL # DIMENSIONS WT/LB. CUBIC FT. LIST PRICE

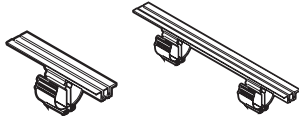

Wire Management - 5" / 22" Track

	W x D x H			
BWMS5	5 x 2 x 3.5	1	0.1	\$6
BWMD22	22 x 2 x 3.5	1.5	0.1	\$15

Retrofittable track mounts to the underside of worksurface. Includes wire clamp that can route data and voice wires separately. Black only. There are no specifications for Wire Management.

- For a 5" track, order model **BWMS5** - includes one wire clamp.
- For a 22" track, order model **BWMD22** - includes two wire clamps.

B BUNGEE™ TABLES

SPIDER LEG TABLES - FLIP-TOP

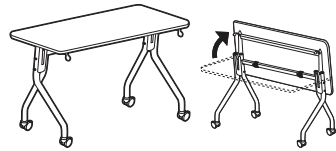
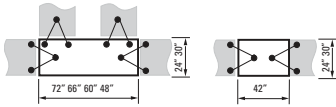

Flip-Top Rectangular Table - Spider Legs*

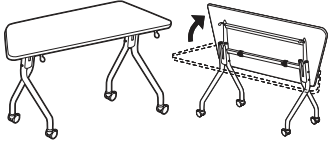
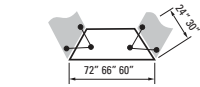

Flip-Top Trapezoid Table - Spider Legs*

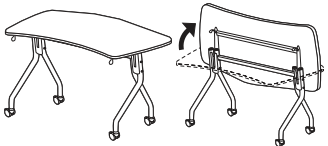

Flip-Top Keystone Table - Spider Legs

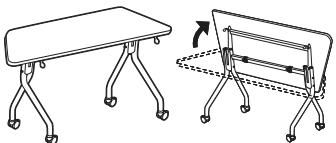

Flip-Top Wedge Table - Spider Legs*

MODEL #	DIMENSIONS	WT/LB.	CUBIC FT.	LIST PRICE
---------	------------	--------	-----------	------------

W x D x H

BX2442RES (HP)	42 x 24 x 29.2	66	20.75	\$1606
BX2448RES (HP)	48 x 24 x 29.2	72	23.5	\$1622
BX2460RES (HP)	60 x 24 x 29.2	84	29	\$1694
BX2466RES (HP)	66 x 24 x 29.2	97	31.75	\$1761
BX2472RES (HP)	72 x 24 x 29.2	102	34.75	\$1796

BX3042RES (HP)	42 x 30 x 29.2	73	25.5	\$1663
BX3048RES (HP)	48 x 30 x 29.2	79	28.75	\$1682
BX3060RES (HP)	60 x 30 x 29.2	94	35.75	\$1774
BX3066RES (HP)	66 x 30 x 29.2	106	39.25	\$1859
BX3072RES (HP)	72 x 30 x 29.2	112	42.5	\$1893

Table features a flip-top worksurface for ease of storage. When **(BB)** or **(BS)** edge option is specified, surface corners are radiused; when **(A3)** edge option is specified, surface corners are square. Single hand release mechanism can be activated from left or right side of the table. Tables can be nested when folded. Each table can be "Bungee-tied" to other tables of the same depth. Shipped in 1 carton. Folding modesty panels available, see page 55.

- **Tables 48" and longer connect in both straight and "L" configurations.**
- Standard with locking casters, specify Black **(TBC)** or Tungsten **(TTC)**.

BX2460TRS (HP)	60 x 24 x 29.2	69	29	\$1594
BX2466TRS (HP)	66 x 24 x 29.2	74	31.75	\$1659
BX2472TRS (HP)	72 x 24 x 29.2	80	34.75	\$1680

BX3060TRS (HP)	60 x 30 x 29.2	72	35.75	\$1668
BX3066TRS (HP)	66 x 30 x 29.2	78	39.25	\$1751
BX3072TRS (HP)	72 x 30 x 29.2	84	42.5	\$1769

Table features a flip-top worksurface for ease of storage. Bubble edge options **(BB)** or **(BS)** only apply (edge option **(A3)** is not applicable on trapezoid tables). Single hand release mechanism can be activated from left or right side of the table. Tables can be nested when folded. Each table can be "Bungee-tied" to other tables of the same depth. Shipped in 1 carton. Folding modesty panels available, see page 55.

- Standard with locking casters, specify Black **(TBC)** or Tungsten **(TTC)**.

BX24KSS (HP)	51 x 24 x 29.2	69	24.75	\$1568
BX30KSS (HP)	62 x 30 x 29.2	79	36.75	\$1747

Table features a flip-top worksurface for ease of storage. When **(BB)** or **(BS)** edge option is specified, surface corners are radiused; when **(A3)** edge option is specified, surface corners are square. Single hand release mechanism can be activated from left or right side of the table. Tables can be nested when folded. Each table can be "Bungee-tied" to other tables of the same depth. Shipped in 1 carton. Modesty panels or filler panels are NOT available.

- Standard with locking casters, specify Black **(TBC)** or Tungsten **(TTC)**.

BX24WES (HP)	63 x 24 x 29.2	76	33	\$2031
BX30WES (HP)	70 x 30 x 29.2	84	33	\$2057

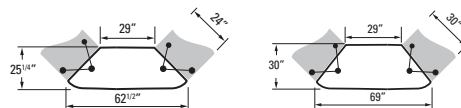

Table features a flip-top worksurface for ease of storage. When **(BB)** or **(BS)** edge option is specified, surface corners are radiused; when **(A3)** edge option is specified, surface corners are square. Single hand release mechanism can be activated from left or right side of the table. Tables can be nested when folded. Each table can be "Bungee-tied" to other tables of the same depth. Shipped in 1 carton. Folding modesty panels available, see page 55.

- Standard with locking casters, specify Black **(TBC)** or Tungsten **(TTC)**.

Required specifications

Top finish*
Edge detail*
Leg finish*

Optional specifications

Grommet*
Power block cut-out*

Accessories

Power block*

MODESTY PANELS - FLIP-TOP - SQUARE **MODEL #** **DIMENSIONS** **WT/LB.** **CUBIC FT.** **LIST PRICE** **HP ADD**

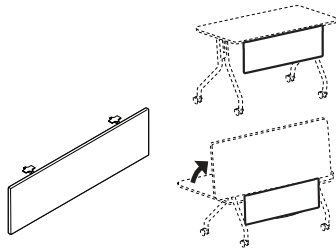

Modesty Panel - Square

	W x D x H				
BX36QMP	21 x 0.69 x 9.6	6	0.9	\$97	
BX42QMP	27 x 0.69 x 9.6	7	1.1	\$101	
BX48QMP	33 x 0.69 x 9.6	9	1.2	\$109	
BX60QMP	45 x 0.69 x 9.6	12	1.6	\$117	
BX66QMP	51 x 0.69 x 9.6	13	1.8	\$123	
BX72QMP	57 x 0.69 x 9.6	14	2	\$127	

For use on **flip-top rectangular tables**. Includes hinged mounting bracket. Available in standard line finishes. Edging only available in Silver (**SI**) or Black (**BK**). Please specify.

- Modesty panel model number indicates the width of table to be used on.

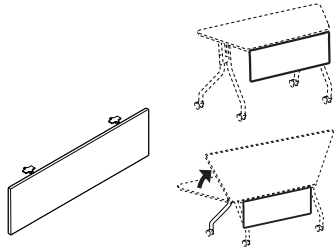

Modesty Panel - Square

BXM60QMP	27 x 0.69 x 9.6	7	1.1	\$101	
BXM66QMP	33 x 0.69 x 9.6	9	1.2	\$109	
BXM72QMP	39 x 0.69 x 9.6	10	1.4	\$113	
BXL60QMP	21 x 0.69 x 9.6	6	0.9	\$98	
BXL66QMP	27 x 0.69 x 9.6	7	1.1	\$101	
BXL72QMP	33 x 0.69 x 9.6	9	1.2	\$109	

For use on **flip-top trapezoid tables**. Includes hinged mounting bracket. Intended for use on the short side of the table; may be used on long side but leaves a larger gap. Available in standard line finishes. Edging only available in Silver (**SI**) or Black (**BK**). Please specify.

- Modesty panel model number indicates the width of table to be used on.

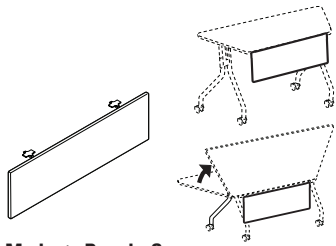

Modesty Panel - Square

BXWQMP	27 x 0.69 x 9.6	7	1.1	\$101	
--------	-----------------	---	-----	--------------	--

For use on **flip-top wedge tables**. Includes hinged mounting bracket. Intended for use on the short side of the table. Available in standard line finishes. Edging only available in Silver (**SI**) or Black (**BK**). Please specify.

- Modesty panel model number indicates the width of table to be used on.

Required specifications

- Modesty panel finish
- Edge finish



Designed by Zoey Chu, Junction provides an affordable solution for your table applications. Choose from a variety of table top designs: rectangular, half round, trapezoid and keystone to create a unique table for your boardroom, classroom or presentation room application.

A freestanding or shared leg configuration with the unique “Y” leg allows you to either create a permanent table or one that can be reconfigured quickly and easily. A straight leg is available for use with half round and keystone tops.

Shared leg configurations allow more legroom and can also decrease cost because they use fewer components. Freestanding configurations provide more flexibility for changing environments.

Features and Benefits

- Tops are 1” thick and constructed of 45 lb. density particle board.
- 2mm matching edge is standard.
- Optional radius corners (**RM**) available at no upcharge.
- Optional modesty panel with integrated wire trough available.
- Casters available with or without manual locks provide mobility.
- Black grommets for convenient wire management can be ordered factory installed.
- Optional, easy-to-use thumbscrews allow installation without tools.
- Junction tops are available in Global laminate finishes with two leg options.



Y leg design.



Modesty panel.



Shared leg configuration provides more legroom and decreases the overall costs.

GENERAL INFORMATION

- Junction is a series of multi-purpose tables for classroom, training room and boardroom applications.
- Unique design by Zooey Chu.
- Half round, trapezoid and keystone tops are available to create a variety of package configurations.
- Rectangular tops are available in 24" and 30" depths.
- Optional modesty panels with integrated wire troughs are available.
- Optional large electrical manager provides a safe environment for equipment wires.
- Shipped easy to assemble. Each component is packaged individually; legs are shipped 1 per carton.
- For environmental certifications, please visit globalfurnituregroup.com.

WORKSURFACES

- Tops are 1" thick, made of 45 lb. density particle board.
- Laminate finishes are high pressure.

CONSTRUCTION

- Rectangular tops 54" in length and longer include a steel support channel for structural rigidity.
- Tops are predrilled with threaded steel inserts.
- Adjustable levelers offer up to 1" adjustability.

EDGE DETAIL

- Global's preferred matching edge is standard.
- Optional radius corners (**RM**) are available on rectangular tops at no upcharge.

LEGS

- Unique Y design.
- Straight leg available for assembly with half round tops and keystone tops.
- Heavy duty steel construction.
- Coated with environmentally friendly recycled paint that provides a durable finish.
- Black plastic leveling glides offer $\frac{5}{8}$ " adjustability.
- Available in Black (**TBL**), Cloud (**TIV**), Designer White (**TDW**), Fog (**TFO**), Frost (**TFR**), Kalua (**TKA**), Latte (**TLA**), Mocha (**TMO**), Nevada (**TNE**), Sand (**TSN**), Shadow (**TSH**), Toast (**TOA**) or Tungsten (**TTU**) finish.
- Y legs: 21.5" leg span - 24"D top, 24.5" leg span - 30"D top.

CASTERS

- Optional casters are available.
- 1.5" dual wheel casters with or without manual lock. Full 360° swivel.
- Can be used in any combination with or without standard glides.
- Suggested for carpeted surfaces.
- Available in Black only.
- Sold in packages of two.

GANGING

- Ganging plates are available for ganging workstations together.
- Ganging plates are Black epoxy coated steel plates with two thumbscrews.
- Provides maximum stability and torque reduction.

WIRE MANAGEMENT

- Available for managing additional larger wires and power connectors.
- 3.5" high x 4.25" deep Black PVC channel attaches to the underside of top.

SPECIFICATIONS

- Specifications marked with an * are applicable to only those products which have the * symbol beside the product name.

1. SPECIFY MODEL NUMBER

2. SPECIFY FINISH

Laminate Finishes:

ACJ Absolute Acajou	FCL First Class
ASN Asian Night	NBL Noce Biondo
AWC Avant Cherry	NGL Noce Grigio
AWH Avant Honey	NEL Noce Leggero
BLK Black	NML Noce Medio
BZD Blizzard	QTM Quartered Mahogany
BRC Brushed Cobalt	SBY Sheer Beauty
CMB Clear Maple	SDT Stonedust
CGY Custom Grey	SOG Storm Grey
DES Dark Espresso	WHE Walnut Heights
DWT Designer White	WHC White Chocolate
FAS Fashionista	WCR Winter Cherry

Legs:

TBL Black	TMO Mocha
TIV Cloud	TNE Nevada
TDW Designer White	TSN Sand
TFO Fog	TSH Shadow
TFR Frost	TOA Toast
TKA Kalua	TTU Tungsten
TLA Latte	

3. SPECIFY OPTIONS

MODESTY PANELS

- 11.25" high panel attaches to the underside of worksurface top.
- Standard with integrated wire trough.
- Available in Black PVC.

GROMMETS

- Grommets are available in **rectangular and trapezoid** tops (left, center or right). See below for available locations. Order as: **FOG1, FOG2** or **FOG3**. Add \$91. For **keystone** worksurface locations, order as **FOG2**. Add \$91.
- Grommet hole dimensions are 3.25" wide x 1.875" deep.

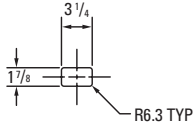

- Grommets may be placed at non-standard locations. Order as: **CSG**. Add \$132. A drawing must be supplied with vertical and horizontal dimensions to the center of the cut-out (as in drawing above). Please refer to the **custom grommet location form** in the back reference section.

EXAMPLES OF GROMMET AND POWER BLOCK POSITIONS

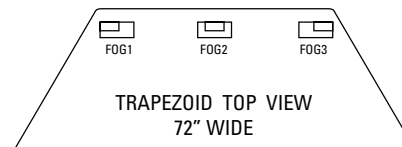
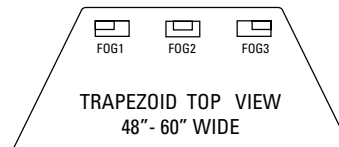
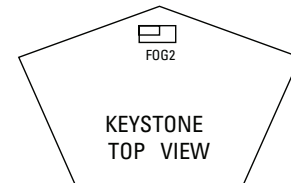
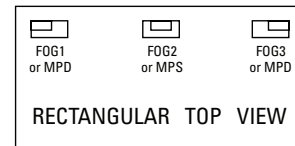

MODPOWER DAISY CHAIN SOLUTION

- Add flexible power and USB charging to Junction **rectangular tables** only. Connect up to four units with a single corded infeed with NEMA plug.
- ModPower units are sold separately, refer to Productivity Solutions page 88.
- Begin run with a starter unit which includes a corded infeed. Add additional middle or end units as required. Middle and end units are equipped with connecting cables.
- On-surface modules clamp on or screw mount to the table tops.
- In-surface modules require table top cut-outs for mounting (cannot be used with modesties). Specify cut-out option:
 - **MPS** for a single cut-out to accommodate one ModPower in-surface unit (cut-out will be centered on the approach side) for **30" to 72" wide rectangular tables**. Add \$91.
 - **MPD** for two cut-outs in the left and right positions, 15" from ends to center of unit on approach side for 60", 66" and 72" wide rectangular tables. Add \$183.

RECTANGULAR TOPS **MODEL #** **DIMENSIONS** **WT/LB.** **CUBIC FT.** **LIST PRICE**

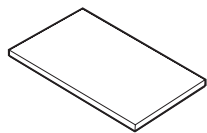

Rectangular Top*

	W x D x H			
JNR2442 (HP)	42 x 24 x 1	31	1.25	\$315
JNR2448 (HP)	48 x 24 x 1	35	1.4	\$340.50
JNRU2454 (HP)	54 x 24 x 1	42	1.52	\$475.50
JNRU2460 (HP)	60 x 24 x 1	47	1.67	\$505.50
JNRU2466 (HP)	66 x 24 x 1	52	1.82	\$547.50
JNRU2472 (HP)	72 x 24 x 1	57	2	\$585
JNR3042 (HP)	42 x 30 x 1	38	1.51	\$372
JNR3048 (HP)	48 x 30 x 1	44	1.7	\$405
JNRU3054 (HP)	54 x 30 x 1	52	1.9	\$543
JNRU3060 (HP)	60 x 30 x 1	59	2.1	\$579
JNRU3066 (HP)	66 x 30 x 1	64	2.26	\$622.50
JNRU3072 (HP)	72 x 30 x 1	70	2.5	\$663

Predrilled with threaded steel inserts for freestanding and linking installations. **Tops 54" and longer are standard with a 16 gauge steel support channel.**

HALF ROUND TOPS

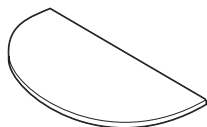

Half Round Top

JNHFS2448 (HP)	48 x 24 x 1	34	1.4	\$375
JNHFS2454 (HP)	54 x 27 x 1	38.25	1.52	\$472.50
JNHFS3060 (HP)	60 x 30 x 1	53	1.67	\$502.50
JNHFS3066 (HP)	66 x 33 x 1	58.3	1.82	\$646.50

Predrilled with threaded steel inserts for freestanding and linking installations. Four legs are required for freestanding configurations.

- **JNHFS2448/JNHFS2454** for use with 24" deep joining edge.
- **JNHFS3060/JNHFS3066** for use with 30" deep joining edge.

TRAPEZOID TOPS

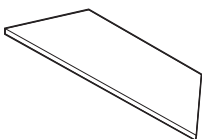

Trapezoid Top

JNTT2448 (HP)	48 x 20.5 x 1	33	1.4	\$358.50
JNTT2460 (HP)	60 x 20.5 x 1	41.25	1.67	\$435
JNTT3060 (HP)	60 x 25.75 x 1	50.5	2.1	\$471
JNTT3072 (HP)	72 x 25.75 x 1	61	2.5	\$537

Predrilled with threaded steel inserts for freestanding and linking installations.

- **JNTT2448/JNTT2460** for use with 24" deep joining edge.
- **JNTT3060/JNTT3072** for use with 30" deep joining edge.

KEYSTONE TOPS

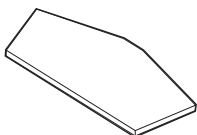

Keystone Tops*

JN5S2424 (HP)	42 x 24 x 1	35	1.4	\$405
JN5S3030 (HP)	54 x 30 x 1	53	2.1	\$517.50

Predrilled with threaded steel inserts for freestanding and linking installations. Three legs are required for freestanding configurations.

- **JN5S2424** for use with 24" deep joining edge.
- **JN5S3030** for use with 30" deep joining edge.

Required specifications
Finish

Optional specifications
Grommet*

Accessories
Power block*

MODESTY PANELS



Modesty Panel

MODEL #	DIMENSIONS	WT/LB.	CUBIC FT.	LIST PRICE
---------	------------	--------	-----------	------------

W x D x H

JNMP42	29.19 x 6.92 x 11.25	3.7	1.5	\$186
JNMP48	35.19 x 6.92 x 11.25	4.5	1.75	\$210
JNMP54	41.19 x 6.92 x 11.25	5	2	\$234
JNMP60	47.19 x 6.92 x 11.25	5.9	2.25	\$260
JNMP66	53.19 x 6.92 x 11.25	6.6	2.5	\$274
JNMP72	59.19 x 6.92 x 11.25	7.4	2.75	\$300

For use with **JNR rectangular tops**. 11.25" high, Black plastic, attractive ribbed design. Includes integrated wire trough. Connects to predrilled holes in table top.

WIRE MANAGEMENT

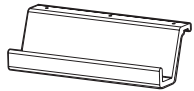

Wire Manager

JNEC5S	12.5 x 4.14 x 3.63	1	0.1	\$46
--------	--------------------	---	-----	-------------

For use with **JN5S keystone**. For managing additional wires and power connectors. 3.5" high Black PVC channel connects to predrilled holes in table top.



Wire Manager



JNEC42	41.75 x 4.14 x 3.63	2.52	0.33	\$117
JNEC48	47.75 x 4.14 x 3.63	2.88	0.38	\$139
JNEC54	53.75 x 4.14 x 3.63	3.24	0.43	\$153
JNEC60	59.75 x 4.14 x 3.63	3.6	0.48	\$172
JNEC66	65.75 x 4.14 x 3.63	3.96	0.53	\$172
JNEC72	71.75 x 4.14 x 3.63	4.32	0.58	\$234

For use with **JNR rectangular tops**. For managing additional wires and power connectors. 3.5" high Black PVC channel connects to predrilled holes in the table top.

Required specifications
Finish (keystone)

Optional specifications

Accessories

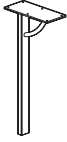
LEGS	MODEL #	DIMENSIONS	WT/LB.	CUBIC FT.	LIST PRICE
 <p>"Y" Leg</p>	W x D x H				
	JNLEG24	2 x 21.5 x 27.3	10	2.5	\$170
<p>Leg span is 21.5". Leveling glides are standard. For assembly with 24" deep tops.</p> <ul style="list-style-type: none"> List price is per each leg. See page 58 for available finishes. 					
 <p>"Y" Leg</p>	W x D x H				
	JNLEG30	2 x 24.5 x 27.3	11	2.85	\$187
<p>Leg span is 24.5". Leveling glides are standard. For assembly with 30" deep tops.</p> <ul style="list-style-type: none"> List price is per each leg. See page 58 for available finishes. 					
 <p>Straight Leg</p>	W x D x H				
	JNLEG	2 x 1 x 27.3	6	1.3	\$155
<p>Leveling glides are standard. For assembly with half round and keystone tops. Mounting plate is 11" deep by 5" wide.</p> <ul style="list-style-type: none"> List price is per each leg. See page 58 for available finishes. 					

Required specifications
Finish (not JNECTxxxx)

J JUNCTION™

CASTERS

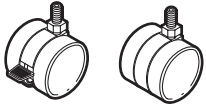

Casters

MODEL

DIMENSIONS

WT/LB.

CUBIC FT.

LIST PRICE

W x D x H

JNCP

- x - x 1.5

-

-

\$30

Set of 2 - 1.5" dual wheel casters, one locking. Suggested for carpeted surfaces. Casters are fully interchangeable with glides. Black only.

- For use with Junction units only.
- Casters DO NOT affect table height.

ACCESSORIES



Thumbscrews

JNTS

1.25 x 1.25 x 1.5

-

-

\$17

Triangular thumbscrew with 0.75" steel thread. Set of 4. Can be used in place of factory supplied screws to allow installation of "Y" legs to tops without tools. Black only.

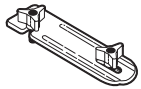

Ganging Flush Plate

JNGFP

2.5 x 5 x 1.13

0.2

0.1

\$28

Black epoxy coated steel plates with 2 thumbscrews included. Used to connect table tops together for additional stability or for connecting freestanding tops together. Holes with steel inserts are located in the corner of the tops to accommodate this plate. Sold individually.

tables

reception and occasional

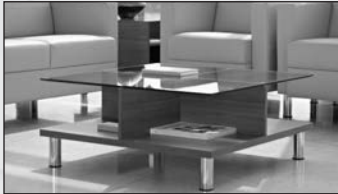

Citi 64

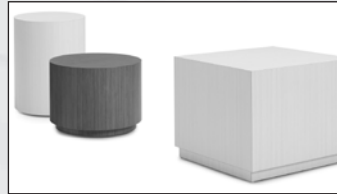

Occasional tables 65



River+ 67



Sirena 69



Soda 70



Wind 71



C CITI TABLES

CITI TABLES

Notes:

- Citi tables complement the contemporary timeless decor of many offices.
- Legs are **standard** in Tungsten (**TTU**) and also available in Black (**TBL**) finish at no upcharge. A Chrome (**CHM**) finish is available. **Add \$68.**
- Table tops are available in either tempered glass or laminate.
- Citi tables are offered in the following finishes to coordinate with Global casegoods and wood seating:

ACJ Absolute Acajou	FCL First Class
ASN Asian Night	NBL Noce Biondo
AWC Avant Cherry	NGL Noce Grigio
AWH Avant Honey	NEL Noce Leggero
BLK Black	NML Noce Medio
BZD Blizzard	QTM Quartered Mahogany
BRC Brushed Cobalt	SBY Sheer Beauty
CMB Clear Maple	SDT Stonedust
CGY Custom Grey	SOG Storm Grey
DES Dark Espresso	WHE Walnut Heights
DWT Designer White	WHC White Chocolate
FAS Fashionista	WCR Winter Cherry

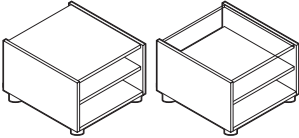
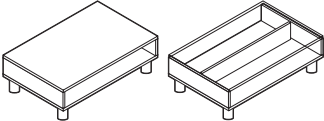
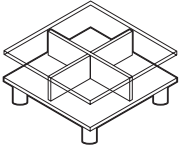
CITI TABLES	MODEL #	DIMENSIONS	WT/LB.	CUBIC FT.	LIST PRICE
W x D x H					
 <p>End Table</p>	7885 (laminate top)	20 x 24 x 20	45	6	\$751
	7886 (glass top)	20 x 24 x 20	52	6	\$981
Metal tubular legs. Laminate or tempered glass tops available. Shipped assembled in 1 carton.					
 <p>Coffee Table - Rectangular</p>	7887 (laminate top)	40 x 20 x 15	50	6.5	\$784
	7888 (glass top)	40 x 20 x 15	65	6.5	\$1133
Metal tubular legs. Laminate or tempered glass tops available. Shipped assembled in 1 carton.					
 <p>Coffee Table - Square</p>	7889 (glass top)	33 x 33 x 15	80	8.75	\$1347
Metal tubular legs. Tempered glass top. Shipped assembled in 1 carton.					

Required specifications

Top finish
Leg finish

CYLINDER AND CUBE OCCASIONAL TABLES

Notes:

- High pressure laminate exterior with adjustable plastic glides.
- Premium cylinder tables have a flexible plywood core construction ideal for institutional and high traffic environments.
- Ideal for reception areas - colors coordinate with all Global desks, conference tables and accessories.
- Shipped assembled in 1 carton.
- WT/LB. are shipping weights.
- Available to either match or coordinate with most Global laminate desk series. Available finishes:

ACJ Absolute Acajou	FCL First Class
ASN Asian Night	NBL Noce Biondo
AWC Avant Cherry	NGL Noce Grigio
AWH Avant Honey	NEL Noce Leggero
BLK Black	NML Noce Medio
BZD Blizzard	QTM Quartered Mahogany
BRC Brushed Cobalt	SBY Sheer Beauty
CMB Clear Maple	SDT Stonedust
CGY Custom Grey	SGG Storm Grey
DES Dark Espresso	WHE Walnut Heights
DWT Designer White	WHC White Chocolate
FAS Fashionista	WCR Winter Cherry

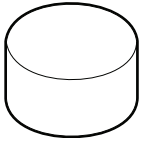
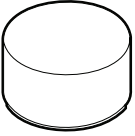
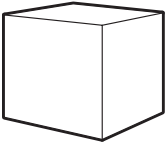
CYLINDER AND CUBE OCCASIONAL TABLES	MODEL #	DIMENSIONS	WT/LB.	CUBIC FT.	LIST PRICE
 <p>Premium Cylinder Tables</p>	W x D x H				
	CPFD1816	18 x - x 16	23	6.5	\$832
	CPFD1821	18 x - x 21	26.5	8	\$856
	CPFD2416	24 x - x 16	32.5	11	\$865
	CPFD2421	24 x - x 21	35	12.5	\$886
	CPFD3016	30 x - x 16	45.5	15.5	\$1024
	CPFD3021	30 x - x 21	48	17	\$1079
¹¹ / ₃₂ " thick flexible plywood covered in high pressure laminate. Adjustable plastic glides. Flush base.					
 <p>Premium Plinth Cylinder Tables</p>	CPPD1816	18 x - x 16	27.5	6.5	\$877
	CPPD1821	18 x - x 21	31	8	\$898
	CPPD2416	24 x - x 16	38.7	11	\$908
	CPPD2421	24 x - x 21	41.2	12.5	\$931
	CPPD3016	30 x - x 16	54.5	15.5	\$1038
	CPPD3021	30 x - x 21	57	17	\$1138
¹¹ / ₃₂ " thick flexible plywood covered in high pressure laminate. Adjustable plastic glides. Recessed base.					
 <p>Cube Table</p>	CU1816	18 x 18 x 16	26	3.3	\$502
	CU1821	18 x 18 x 21	30	4	\$544
	CU2416	24 x 24 x 16	38	6	\$526
	CU2421	24 x 24 x 21	43.5	7	\$569
	CU3016	30 x 30 x 16	50.8	6.5	\$553
	CU3021	30 x 30 x 21	57.5	8	\$595
0.75" thick plywood covered in high pressure laminate. Adjustable plastic glides. Flush base.					

Required specifications

Finish

0 OCCASIONAL TABLES

CYLINDER AND CUBE OCCASIONAL TABLES

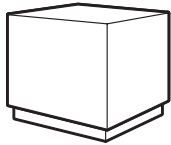

Plinth Cube Table

MODEL #	DIMENSIONS W x D x H	WT/LB.	CUBIC FT.	LIST PRICE
CUP1816	18 x 18 x 16	28	3	\$545
CUP1821	18 x 18 x 21	33.5	4	\$586
CUP2416	24 x 24 x 16	41.5	6	\$573
CUP2421	24 x 24 x 21	48	7	\$615
CUP3016	30 x 30 x 16	53.8	6.5	\$638
CUP3021	30 x 30 x 21	62.3	8	\$695

0.75" thick plywood covered in high pressure laminate. Adjustable plastic glides. **Recessed base.**

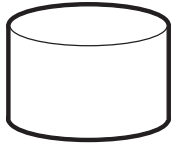

Cylinder Table

CY1816	18 x - x 16	21	3.3	\$465
CY1821	18 x - x 21	27	4.3	\$512
CY2416	24 x - x 16	33	6	\$485
CY2421	24 x - x 21	39	7	\$526
CY3016	30 x - x 16	44.5	8	\$573
CY3021	30 x - x 21	52.7	11	\$616

0.375" thick foundation board covered in high pressure laminate. Adjustable plastic glides. **Flush base.**

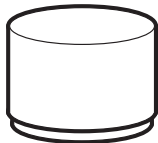

Plinth Cylinder Table

CYP1816	18 x - x 16	26.5	3.3	\$502
CYP1821	18 x - x 21	32	4.3	\$545
CYP2416	24 x - x 16	40	6	\$522
CYP2421	24 x - x 21	46	7	\$564
CYP3016	30 x - x 16	52.3	8	\$614
CYP3021	30 x - x 21	60.5	11	\$654

0.375" thick foundation board covered in high pressure laminate. Adjustable plastic glides. **Recessed base.**

Required specifications

Finish

RIVER+ TABLES

Notes:

River+ tables are made with high pressure laminate and are offered in following finishes to coordinate with Global casegoods and wood seating:

ACJ Absolute Acajou	FCL First Class
ASN Asian Night	NBL Noce Biondo
AWC Avant Cherry	NGL Noce Grigio
AWH Avant Honey	NEL Noce Leggero
BLK Black	NML Noce Medio
BZD Blizzard	QTM Quartered Mahogany
BRC Brushed Cobalt	SBY Sheer Beauty
CMB Clear Maple	SDT Stonedust
CGY Custom Grey	SOG Storm Grey
DES Dark Espresso	WHE Walnut Heights
DWT Designer White	WHC White Chocolate
FAS Fashionista	WCR Winter Cherry

- Legs are straight as standard in Chrome (**CHM**) with Black non-marking height adjustable glides.
- Legs are also available in the following finishes: Black (**TBL**), Cloud (**TIV**), Designer White (**TDW**), Fog (**TFO**), Frost (**TFR**), Kalua (**TKA**), Latte (**TLA**), Mocha (**TMO**), Nevada (**TNE**), Sand (**TSN**), Shadow (**TSH**), Toast (**TOA**) and Tungsten (**TTU**). No upcharge. Please specify.
- The unique tapered legs are made of welded steel, with each leg bolted directly to the unit frame. All units have the same standard leg height of 6.5". The leg height makes it easier to clean under the product. Legs are also available in 3" and 8" heights. All heights are available with fixed-to-floor option. Please specify:
 - (S6) Standard height (6.5") w/adjustable glides. No upcharge. (F6) Standard height (6.5"), fixed to floor. **Add \$90.**
 - (S3) Low (3") w/adjustable glides. No upcharge. (F3) Low (3"), fixed to floor. **Add \$90.**
 - (S8) High (8") w/adjustable glides. No upcharge. (F8) High (8"), fixed to floor. **Add \$90.**
- Products can be weighted to reduce the ease of movement. For additional weight options, please specify (**CW**) - see each model for available additional weight and upcharge.
- Tables can be specified with power/USB units, which include one power outlets, one double USB terminals and a Black 120" 3-prong power cord in predetermined locations - **E1, E2, F3 or T1** as shown in the electrical illustrations below. Electrical units must be factory installed. **Add \$881** per unit.
- Power/USB units are available with either Jet Black (**J**) face plate with Black power/USB receptacles or with a White (**W**) face plate with White power/USB receptacles.
- Tamperproof fasteners (**TP**) are available. Please specify. **Add \$119.**
- Refer to the Seating price list, under lounge seating for the full range of River+ products available.

ELECTRICAL PLACEMENT

Coffee Tables

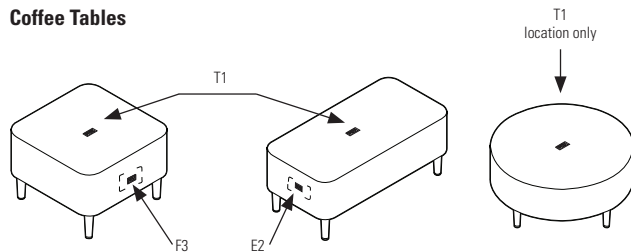

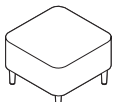
RIVER+ TABLES	MODEL#	DIMENSIONS	WT/LB.	CUBIC FT.	LIST PRICE
		W x D x H			
	R27855	24 x 24 x 17	40	10.7	\$1329
24" Square Laminate Coffee Table		Freestanding unit only. For additional weight, please specify (CW). Add \$533 for 36 lbs. Power/USB units can be specified in position F3 or T1 only. Add \$881.			

Required specifications

- Top finish
- Leg finish/height

Optional specifications

- Power/USB finish
- Power/USB location
- Tamperproof

R RIVER+ TABLES

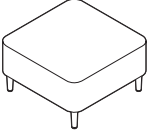
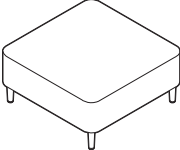
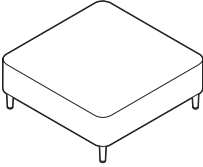
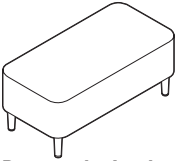
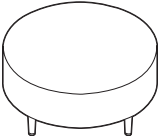
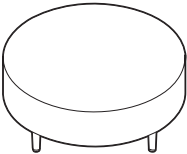
RIVER+ TABLES	MODEL #	DIMENSIONS W x D x H	WT/LB.	CUBIC FT.	LIST PRICE
 <p>30" Square Laminate Coffee Table</p>	R27856	30 x 30 x 17	53	15.3	\$1392
<p>Freestanding unit only. For additional weight, please specify (CW). Add \$400 for 27 lbs. Power/USB units can be specified in position F3 or T1 only. Add \$881.</p>					
 <p>36" Square Laminate Coffee Table</p>	R27857	36 x 36 x 17	75	20.6	\$1541
<p>Freestanding unit only. No additional weight is required. Power/USB units can be specified in position F3 or T1 only. Add \$881.</p>					
 <p>42" Square Laminate Coffee Table</p>	R27858	42 x 42 x 17	115	26.7	\$1706
<p>Freestanding unit only. No additional weight is required. Power/USB units can be specified in position F3 or T1 only. Add \$881.</p>					
 <p>Rectangular Laminate Coffee Table</p>	R27859	40 x 20 x 17	55	14.2	\$1400
<p>Freestanding unit only. For additional weight, please specify (CW). Add \$267 for 18 lbs. Power/USB units can be specified in position E1, E2 or T1 only. Add \$881.</p>					
 <p>36" Dia. Round Laminate Coffee Table</p>	R27860	36 x 36 x 17	63	15.3	\$1729
<p>Freestanding unit only. For additional weight, please specify (CW). Add \$267 for 18 lbs. Power/USB units can be specified in position T1 only. Add \$881.</p>					
 <p>42" Dia. Round Laminate Coffee Table</p>	R27861	42 x 42 x 17	85	20.6	\$1889
<p>Freestanding unit only. No additional weight is required. Power/USB units can be specified in position T1 only. Add \$881.</p>					

Required specifications

Top finish
Leg finish/height

Optional specifications

Power/USB finish
Power/USB location
Tamperproof

SIRENA TABLES

Notes:

- Modern tables for reception areas, meeting rooms, and private office use.
- Sirena tables are offered in the following finishes to coordinate with Global casegoods and wood seating:

ACJ Absolute Acajou	FCL First Class
ASN Asian Night	NBL Noce Biondo
AWC Avant Cherry	NGL Noce Grigio
AWH Avant Honey	NEL Noce Leggero
BLK Black	NML Noce Medio
BZD Blizzard	QTM Quartered Mahogany
CMB Clear Maple	SBY Sheer Beauty
CGY Custom Grey	SDT Stonedust
DES Dark Espresso	WHE Walnut Heights
DWT Designer White	WHC White Chocolate
FAS Fashionista	WCR Winter Cherry

- Laminate tops are 1" thick to coordinate with Global casegoods and wood seating.
- Table legs are available in Black (**TBL**) or Tungsten (**TTU**) at no upcharge. Not available in Chrome.
- Legs are 1.5" steel tubing, tapered toward the bottom of the leg to 0.875", equipped with self-leveling pivoting steel glide.

SIRENA TABLES	MODEL#	DIMENSIONS	WT/LB.	CUBIC FT.	LIST PRICE
---------------	--------	------------	--------	-----------	------------



Coffee Table

		W x D x H			
3400	48 x 22 x 14.5	44	17.25	\$1214	
(laminated top)					
Rectangle coffee table.					

Required specifications
 Top finish
 Leg finish



S SODA TABLES

SODA TABLES

Notes:

- 1" thick thermally fused laminate top surface with 2mm matching edgeband.
- Tables are standard with a Chrome frame with clear polycarbonate glides and are suitable for carpet, rubber or concrete flooring.
- Meets applicable ANSI/BIFMA standards.
- Soda tables are offered in the following finishes to coordinate with Global casegoods and wood seating:

ACJ	Absolute Acajou	NBL	Noce Biondo
ASN	Asian Night	NGL	Noce Grigio
AWC	Avant Cherry	NEL	Noce Leggero
AWH	Avant Honey	NML	Noce Medio
CMB	Clear Maple	WHC	White Chocolate
DES	Dark Espresso	WCR	Winter Cherry
DWT	Designer White		

SODA TABLES	MODEL#	DIMENSIONS	WT/LB.	CUBIC FT.	LIST PRICE
 <p>30" Round Table</p>		W x D x H			
	MVL13016	30 x 30 x 15.25	40	13	\$445
		Shipped assembled in 1 carton.			
 <p>30" Square Table</p>					
	MVL13023	30 x 30 x 15.25	45	13	\$445
		Shipped assembled in 1 carton.			





WIND TABLES

Notes:

- Wind tables complement the modern decor of many offices.
- Legs are standard in Chrome (**CHM**). Also available in Black (**TBL**), Shadow (**TSH**) or Tungsten (**TTU**) finish at no upcharge.
- 1" laminate tops are offered in the following finishes to coordinate with Global casegoods and wood seating:

ACJ Absolute Acajou	FCL First Class
ASN Asian Night	NBL Noce Biondo
AWC Avant Cherry	NGL Noce Grigio
AWH Avant Honey	NEL Noce Leggero
BLK Black	NML Noce Medio
BZD Blizzard	QTM Quartered Mahogany
BRC Brushed Cobalt	SBY Sheer Beauty
CMB Clear Maple	SDT Stonedust
CGY Custom Grey	SOG Storm Grey
DES Dark Espresso	WHE Walnut Heights
DWT Designer White	WHC White Chocolate
FAS Fashionista	WCR Winter Cherry

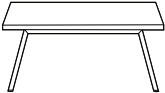
- High pressure laminate (**HPL**) tops are available at a 20% upcharge for models 3366, 3367, 3368, 3870 and 3871. Please specify HPL in addition to the finish. HPL not available for models 3878, 3879 and 3880.

WIND TABLES	MODEL #	DIMENSIONS	WT/LB.	CUBIC FT.	LIST PRICE
		W x D x H			
	3366 (laminate top)	24 x 24 x 17	24	11.5	\$661
End Table					Steel tubular base. Tops are available with a laminate finish. Shipped assembled in 1 carton.
	3367 (laminate top)	48 x 20 x 15	39	16	\$886
Rectangular Coffee Table					Steel tubular base. Tops are available with a laminate finish. Shipped assembled in 1 carton.
	3368 (laminate top)	36 x 36 x 15	50	22	\$1214
Square Coffee Table					Steel tubular base. Tops are available with a laminate finish. Shipped assembled in 1 carton.
	3870 (laminate top)	24 x 24 x 17	30	11.5	\$721
Round Table					Steel tubular base. Tops are available with a laminate finish. Shipped assembled in 1 carton.
	3871 (laminate top)	36 x 36 x 15	50	22	\$1115
Round Coffee Table					Steel tubular base. Tops are available with a laminate finish. Shipped assembled in 1 carton.

Required specifications
Top finish

Optional specifications
Edge detail
Leg finish

W WIND TABLES

WIND TABLES	MODEL #	DIMENSIONS	WT/LB.	CUBIC FT.	LIST PRICE
-------------	---------	------------	--------	-----------	------------

W x D x H

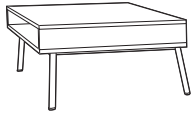

Freestanding Rectangular End Table

3878	20 x 25 x 16	30	11.5	\$1112
------	--------------	----	------	---------------

Steel tubular base. Laminate top is 5" thick with opening on front for storage and visual recess at rear. Shipped assembled in 1 carton.

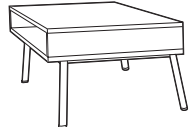

Freestanding Corner Table

3879	25 x 25 x 16	32	11.5	\$1241
------	--------------	----	------	---------------

Steel tubular base. Laminate top is 5" thick with opening on front for storage and visual recess at rear. Shipped assembled in 1 carton.

Required specifications
Top finish

Optional specifications
Edge detail
Leg finish



Productivity Solutions 74



Newland 92



Productivity Solutions by Global is a comprehensive series of ergonomically sound products, naturally connecting people with technology to enhance comfort and productivity. Designed to fit you and your technology and fully integrate with Global products to create complete office solutions that meet the needs of today's diverse workplaces.

Designed with human capabilities and comfort in mind, Productivity Solutions by Global provide a good fit for today's workers and meet or exceed ergonomics standards, guidelines and ANSI/BIFMA standards for performance, durability and safety.

FIT = move + match + support



Monitor arm



Power/data module



Lift-N-lock keyboard mechanism



Manual height adjustable desk

Features and Benefits

- Electric height adjustable table with 18.51" height range.
- Manual height adjustable table has counterbalanced spring mechanism.
- Five keyboard support mechanisms.
- Four keyboard trays.
- New monitor arm options.
- Wire management and power/data options.
- For environmental certifications, please visit globalfurnituregroup.com.

MANUAL HEIGHT ADJUSTABLE TABLES

- Manually operated height adjustable tables with counterbalanced spring mechanism.
- Exceptional ergonomic alternative to traditional desking.
- Sit-stand design promotes increased circulation, improving performance and comfort.
- Can be used alone or in conjunction with Global desking products.
- Tops and bases sold separately.

Please note: Global desk tops are 1”.

TOP FINISHES

ACJ Absolute Acajou	FCL First Class
ASN Asian Night	NBL Noce Biondo
AWC Avant Cherry	NGL Noce Grigio
AWH Avant Honey	NEL Noce Leggero
BLK Black	NML Noce Medio
BZD Blizzard	QTM Quartered Mahogany
BRC Brushed Cobalt	SBY Sheer Beauty
CMB Clear Maple	SDT Stonedust
CGY Custom Grey	SOG Storm Grey
DES Dark Espresso	WHE Walnut Heights
DWT Designer White	WHC White Chocolate
FAS Fashionista	WCR Winter Cherry

CONSTRUCTION

- 1” thick tops constructed of 45 lb. density particle board with high performance laminate and Global’s preferred matching edging.

DIMENSIONS

- When designing workstations, leave 1” clearance on either side to prevent finger pinch.

EDGE

- 2mm edge in matching color.

BASE

- Heavy duty steel formed legs with radius detail are available in Black only.
- Easy to reach tension control supports loads up to 100 lbs.
- Environmentally friendly, recyclable epoxy powder coating provides a durable finish. Black only.
- Black plastic leveling glides offer 0.5” adjustability.

MECHANISM

- Counterbalanced height adjustable base supports weights up to 100 lbs.
- Height range from floor to underside of modesty shroud is 17” when surface height is 26”.
- 7 year warranty.

SHIPPING

- Easy to assemble with Phillips or Robertson screwdriver.

GROMMETS

- Additional grommets available in standard worksurface locations (left, center or right).
- Order as: **FOG1, FOG2 or FOG3. Add \$91.**
- Grommet hole dimensions are 3.25” wide x 1.875” deep.

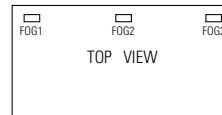

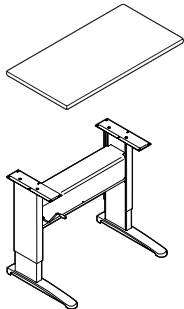
MANUAL HEIGHT ADJUSTABLE TABLES	MODEL #	DIMENSIONS	WT/LB.	CUBIC FT.	LIST PRICE	
 <p>Rectangular Table</p>	W x D x H					
	Tops					
	HTM2446T (HP)	46 x 24 x 1	32	1.5	\$278	
	HTM2458T (HP)	58 x 24 x 1	40	2	\$348	
	HTM3046T (HP)	46 x 30 x 1	40	2	\$337	
HTM3058T (HP)	58 x 30 x 1	50	2.5	\$425		
Base						
KEZLIFT	35.93 x 24 x 25.53	88	5.4	\$1708	N/A	
Tops (HTMXXXXT) sold separately from base (KEZLIFT). Paddle activated height adjustable base. Height adjustable from 26” to 46”. Keyboard tray and mechanism not necessary. Easy to assemble.						
KEZLCSTR	2 x 2 x 2.5	3	0.17	\$20	N/A	
Pack of four locking casters. Interchangeable on site with levelers on KEZLIFT base. Suitable for hard floors.						

Required specifications
Finish

Optional specifications
Grommet

PET FELT PRIVACY SCREEN AND MODESTY PANELS

- PET Felt privacy screens and modesty panels add seated privacy to open plan deskings or tables.
- 9mm thick PET Felt offered in 9 finishes: Black (**BLK**), Brick (**BRI**), Denim (**DEN**), Harvest (**HVT**), Graphite (**GPH**), Mist (**MTS**), Pewter (**PWT**), Shamrock (**SHR**) and White (**WHT**).
- Made from 100% PET (polyester) fiber with a high content of post-recycled material (50%), free of added chemicals, binders and adhesives.
- Lightweight material is tackable, impact and tear resistant, bacteria resistant, moisture resistant, and installation friendly.
- Variation in fiber mix and color are inherent to the character of the product.
- Requires a free clear edge of 1.5"D x length of privacy screen or modesty panel for mounting.
- Privacy screen upmount brackets adapt to 1" thick TFL or 1¹/₁₆" thick HPL tops and do not mar the top surface.

PET FELT PRIVACY SCREEN

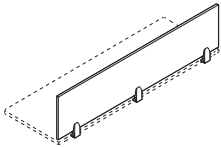

PET Felt Privacy Screen - 1pk.

MODEL #	DIMENSIONS	WT/LB.	CUBIC FT.	LIST PRICE
---------	------------	--------	-----------	------------

W x D x H

PT9PP3013-1	30 x 0.36 x 12.5	2.1	0.6	\$184
PT9PP3613-1	36 x 0.36 x 12.5	2.4	0.7	\$195
PT9PP4213-1	42 x 0.36 x 12.5	2.6	0.8	\$261
PT9PP4813-1	48 x 0.36 x 12.5	3.3	0.9	\$272
PT9PP5413-1	54 x 0.36 x 12.5	3.6	1	\$340
PT9PP6013-1	60 x 0.36 x 12.5	3.8	1.1	\$350
PT9PP6613-1	66 x 0.36 x 12.5	4.5	1.3	\$416
PT9PP7213-1	72 x 0.36 x 12.5	4.8	1.4	\$426
PT9PP7813-1	78 x 0.36 x 12.5	5	1.5	\$437

PET Felt Privacy Screen available in nine finishes, please specify finish. 2, 3 or 4 clamps are included depending on width. Clamps available in satin anodized finish only.

- Up to 42"w - 2 clamps per
- 48"-60"w - 3 clamps per
- 66"-78"w - 4 clamps per

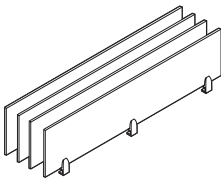

PET Felt Privacy Screen - 4pk.

PT9PP3013-4	30 x 0.36 x 12.5	7.6	0.6	\$701
PT9PP3613-4	36 x 0.36 x 12.5	8.6	0.7	\$741
PT9PP4213-4	42 x 0.36 x 12.5	9.5	0.8	\$1001
PT9PP4813-4	48 x 0.36 x 12.5	11.9	1	\$1041
PT9PP5413-4	54 x 0.36 x 12.5	12.8	1.1	\$1305
PT9PP6013-4	60 x 0.36 x 12.5	13.8	1.2	\$1340
PT9PP6613-4	66 x 0.36 x 12.5	16.2	1.3	\$1600
PT9PP7213-4	72 x 0.36 x 12.5	17.1	1.4	\$1636
PT9PP7813-4	78 x 0.36 x 12.5	18	1.5	\$1669

Pack of four PET Felt Privacy Screens available in nine finishes, please specify finish. 2, 3 or 4 clamps are included depending on width. Clamps available in satin anodized finish only.

- Up to 42"w - 2 clamps per
- 48"-60"w - 3 clamps per
- 66"-78"w - 4 clamps per

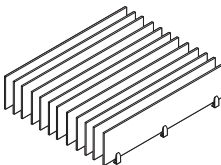

PET Felt Privacy Screen - 12pk.

PT9PP3013-12	30 x 0.36 x 12.5	21.6	1.9	\$2060
PT9PP3613-12	36 x 0.36 x 12.5	24.3	2.3	\$2171
PT9PP4213-12	42 x 0.36 x 12.5	26.9	2.6	\$2945
PT9PP4813-12	48 x 0.36 x 12.5	33.8	3	\$3052
PT9PP5413-12	54 x 0.36 x 12.5	36.4	3.4	\$3837
PT9PP6013-12	60 x 0.36 x 12.5	39	3.7	\$3933
PT9PP6613-12	66 x 0.36 x 12.5	45.9	4.2	\$4706
PT9PP7213-12	72 x 0.36 x 12.5	48.5	4.5	\$4801
PT9PP7813-12	78 x 0.36 x 12.5	51.1	4.9	\$4897

Pack of twelve PET Felt Privacy Screens available in nine finishes, please specify finish. 2, 3 or 4 clamps are included depending on width. Clamps available in satin anodized finish only.

- Up to 42"w - 2 clamps per
- 48"-60"w - 3 clamps per
- 66"-78"w - 4 clamps per

Required specifications

Finish

PET FELT MODESTY PANEL **MODEL #** **DIMENSIONS** **WT/LB.** **CUBIC FT.** **LIST PRICE**

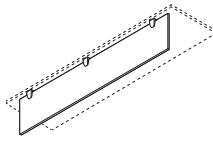

PET Felt Modesty Panel - 1 pk.

	W x D x H			
PT9MP3013-1	30 x 0.36 x 12.5	2.1	0.6	\$160
PT9MP3613-1	36 x 0.36 x 12.5	2.4	0.7	\$172
PT9MP4213-1	42 x 0.36 x 12.5	2.6	0.8	\$227
PT9MP4813-1	48 x 0.36 x 12.5	3.3	0.9	\$238
PT9MP5413-1	54 x 0.36 x 12.5	3.6	1.03	\$305
PT9MP6013-1	60 x 0.36 x 12.5	3.8	1.1	\$315
PT9MP6613-1	66 x 0.36 x 12.5	4.5	1.3	\$371
PT9MP7213-1	72 x 0.36 x 12.5	4.8	1.4	\$381
PT9MP7813-1	78 x 0.36 x 12.5	5	1.5	\$390

PET Felt Modesty Panel available in nine finishes, please specify finish. 2, 3 or 4 clamps are included depending on width. Clamps available in satin anodized finish only. **Specify a nominal size 6" shorter than worksurface size.**

- Up to 42"w - 2 clamps per
- 48"-60"w - 3 clamps per
- 66"-78"w - 4 clamps per

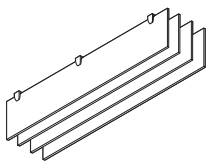

PET Felt Modesty Panel - 4 pk.

PT9MP3013-4	30 x 0.36 x 12.5	7.6	0.6	\$611
PT9MP3613-4	36 x 0.36 x 12.5	8.6	0.7	\$651
PT9MP4213-4	42 x 0.36 x 12.5	9.5	0.8	\$866
PT9MP4813-4	48 x 0.36 x 12.5	11.9	1	\$906
PT9MP5413-4	54 x 0.36 x 12.5	12.8	1.1	\$1169
PT9MP6013-4	60 x 0.36 x 12.5	13.8	1.2	\$1205
PT9MP6613-4	66 x 0.36 x 12.5	16.2	1.3	\$1420
PT9MP7213-4	72 x 0.36 x 12.5	17.1	1.4	\$1455
PT9MP7813-4	78 x 0.36 x 12.5	18	1.5	\$1490

Pack of four PET Felt Modesty Panels available in nine finishes, please specify finish. 2, 3 or 4 clamps are included depending on width. Clamps available in satin anodized finish only. **Specify a nominal size 6" shorter than worksurface size.**

- Up to 42"w - 2 clamps per
- 48"-60"w - 3 clamps per
- 66"-78"w - 4 clamps per

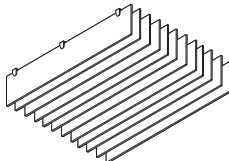

PET Felt Modesty Panel - 12 pk.

PT9MP3013-12	30 x 0.36 x 12.5	21.6	1.9	\$1790
PT9MP3613-12	36 x 0.36 x 12.5	24.3	2.3	\$1902
PT9MP4213-12	42 x 0.36 x 12.5	26.9	2.6	\$2538
PT9MP4813-12	48 x 0.36 x 12.5	33.8	3	\$2646
PT9MP5413-12	54 x 0.36 x 12.5	36.4	3.4	\$3432
PT9MP6013-12	60 x 0.36 x 12.5	39	3.7	\$3527
PT9MP6613-12	66 x 0.36 x 12.5	45.9	4.2	\$4164
PT9MP7213-12	72 x 0.36 x 12.5	48.5	4.5	\$4260
PT9MP7813-12	78 x 0.36 x 12.5	51.1	4.9	\$4356

Pack of twelve PET Felt Modesty Panels available in nine finishes, please specify finish. 2, 3 or 4 clamps are included depending on width. Clamps available in satin anodized finish only. **Specify a nominal size 6" shorter than worksurface size.**

- Up to 42"w - 2 clamps per
- 48"-60"w - 3 clamps per
- 66"-78"w - 4 clamps per

Required specifications

Finish

MONITOR ARMS

- Free up valuable space on surfaces.
- Attach to any standard 1" to 1.5" thick surface with flush edge by a desk clamp or through a grommet. Mounting hardware included.
- Clamps on worksurfaces 0.5" to 2.625" thick.
- For use in grommets up to 3.5" wide.
- Built-in cable management.
- Quick connect option is standard with hole patterns to meet Video Electronics Standards Association (VESA) standards (75mm x 75mm or 100mm x 100mm).
- Monitor arm components are 100% recycled aluminum die cast material, providing stability and durability.
- Available finishes: Silver (**SIL**) standard (except where noted otherwise).

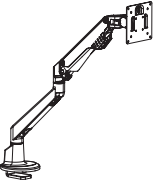
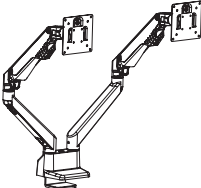
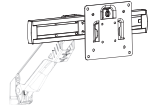
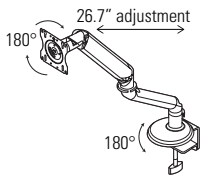
MONITOR ARMS	MODEL #	DIMENSIONS	WT/LB.	CUBIC FT.	LIST PRICE
 <p>G7 Single Monitor Arm</p>		W x D x H			
	PSMA1	- x 5.5 x 21	6.6	0.4	\$418
<p>For use with a monitor weighing 4.4 to 19.8 lbs. Adjustable counterbalance provides free floating fingertip control. Maximum of 20.5" extension from rear of desk to back of monitor, folds to 4.5". Monitor can rotate for portrait or landscape viewing with -90° to 45° tilt adjustment. 180° lockout function. Maximum monitor width of 34". Some assembly required. Tungsten finish only. Also accommodates mini slide arm PSMS.</p>					
 <p>G7 Double Monitor Arm</p>					
	PSMA2	- x 5.5 x 21	12.8	1	\$734
<p>For use with monitors weighing 4.4 to 19.8 lbs. Adjustable counterbalance provides free floating fingertip control. Maximum of 20.5" extension from rear of desk to back of monitor, folds to 4.5". Monitor can rotate for portrait or landscape viewing with -90° to 45° tilt adjustment. 180° lockout function. Maximum monitor width of 34" (per arm). Some assembly required. Tungsten finish only. Also accommodates mini slide arm PSMS.</p> <p><i>*Must be specified with quantity two (2) PSMS mini slides for monitor arms, not included.</i></p>					
 <p>G7 Mini Slide for Monitor Arm</p>					
	PSMS	11 x 6 x 4.5	3.3	0.3	\$145
<p>The mini slide is for use with PSMA1 and PSMA2 monitor arms only. Provides 9" of lateral adjustment for the monitor and allows for better positioning of monitors when used side by side. Some assembly required. Tungsten finish only.</p> <ul style="list-style-type: none"> • If for PSMA1, order one (1) • If for PSMA2, order two (2) 					
 <p>Single Screen Double Extension Arm - Light Duty</p>					
	M7750LD	5.5 x 4.5-22.7 x 24.4	7.5	1.12	\$512
<p>For use with monitors weighing 5 to 20 lbs. Adjustable counterbalance provides free floating fingertip control. Maximum of 26.7" extension from rear of desk to back of monitor; folds to 4.5". Monitor can rotate 180° for portrait or landscape viewing with -90° to 45° tilt adjustment. Integral monitor weight adjustment gauge. Aluminum die cast construction. VESA plate edge clamp and grommet mount included. Silver finish. Some assembly required.</p> <ul style="list-style-type: none"> • Also available in Black finish #M7750LDB or White finish #M7750LDW. 					

Required specifications

Finish

MONITOR ARMS	MODEL #	DIMENSIONS	WT/LB.	CUBIC FT.	LIST PRICE
--------------	---------	------------	--------	-----------	------------

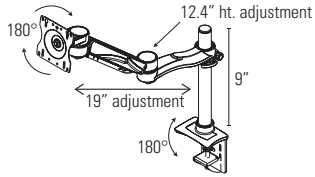

Single Screen Double Extension Arm with Height Adjustment

W x D x H					
MON1SDEH	29.3 x 9.5 x 12.5	8.2	1.1	\$533	

Counterbalanced arm provides an additional 12.4" of height adjustment. Double extension allows 19" of horizontal back and forth movement. Easy to use Allen wrench allows user to adjust the counterbalance mechanism for easy movement of the monitor. Displays are able to tilt 180°, swing 180° side-to-side and rotate from landscape to portrait. Cable manager comes on extension arm and hides all cables. Supports a 20 lb. load capacity. No maximum monitor width. Minor assembly required.

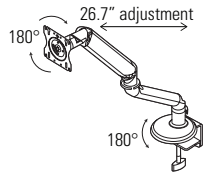

Single Screen Double Extension Arm - Medium Duty

M7755MD	5.5 x 4.5-22.7 x 24.4	7.5	1.12	\$548	
---------	-----------------------	-----	------	--------------	--

For use with monitors weighing 10 to 30 lbs. Adjustable counterbalance provides free floating fingertip control. Maximum of 26.7" extension from rear of desk to back of monitor; folds to 4.5". Monitor can rotate 180° for portrait or landscape viewing with -90° to 45° tilt adjustment. Integral monitor weight adjustment gauge. Aluminum die cast construction. VESA plate edge clamp and grommet mount included. Silver finish. Some assembly required.

- Also available in **Black finish** #M7755MDB or **White finish** #M7755MDW.

Required specifications
Finish

KEYBOARD TRAYS MODEL # DIMENSIONS WT/LB. CUBIC FT. LIST PRICE

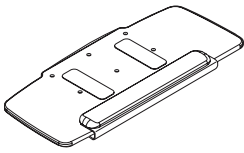

27" HDPE Tray

	W x D x H			
KT27M02	27.5 x 11.5 x 0.38	6	0.4	\$263

Allows mouse to be easily positioned at the same height as, and to the left or right of the keyboard. Palm rest is easily removable. Includes anti-slip strips. High density polyethylene (HDPE) surface material. Self-skinned urethane (SSU) palm rest. Compatible with all Global keyboard mechanisms.

- *Specify mechanism separately, see pages 81-81.*

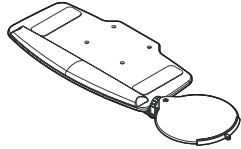

Tray with Height Adjustable Mouse Support - Black

KTMT03	23 x 11.5 x 2.8	5.8	0.6	\$284
--------	-----------------	-----	-----	--------------

Low profile tray with highly adjustable mouse support that allows the user to position the mouse surface according to their needs and preferences. Mouse support features include: height adjustment, swivel and tilt. User can easily mount on left or right side of keyboard tray, easily swivel and adjust the height position to maintain neutral postures, and independently adjust the mouse surface tilt so mouse stays on the support when the keyboard tray is tilted. Compatible with all Global keyboard mechanisms. Palm rest is easily removable. Includes mouse fence with cable manager and anti-slip strips. Keyboard tray is 23"W x 11.5"D and mouse support is 11" in diameter. Tray support material a compact phenolic panel, mouse tray in ABS plastic. Plug-in gel-feel foam palm rest.

- *Specify mechanism separately, see pages 81-81.*

KEYBOARD TRAYS / MECHANISMS **MODEL #** **DIMENSIONS** **WT/LB.** **CUBIC FT.** **LIST PRICE**

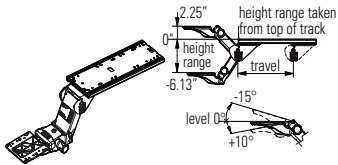

Lift-N-Lock Keyboard Support Mechanism

	W x D x H			
KSM02-21	9 x 23.8 x 9.7	9.7	0.7	\$266
KSM02-18	7.4 x 19.7 x 8.2	8	0.6	\$266
KSM02-12	5 x 13.1 x 5.4	5.4	0.4	\$266

Knobless height adjustment and independent tilt adjustment. Locks automatically into position with release of tray. Positive tilt lockout available by special order with extended lead time. Compatible with all Global keyboard mechanisms. Good for single users who frequently change positions and for multiple users. Swivels 360°.

- KSM02-21 requires 21.75" of depth clearance under the surface for installation.
- KSM02-18 requires 18" of depth clearance under the surface for installation.
- KSM02-12 requires 12" of depth clearance under the surface for installation.
- *Specify keyboard tray separately, see page 80.*

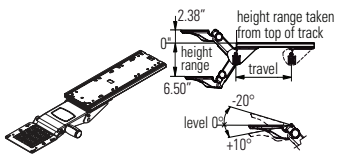

Slim Fit Keyboard Support Mechanism

Black

KSFK-21	7.5 x 23.8 x 4.75	5.4	0.6	\$266
KSFK-18	7.5 x 19.7 x 4.75	5.4	0.5	\$266
KSFK-12	7.5 x 13.1 x 4.75	5.4	0.5	\$266

Warm White

KSFK-21-W	7.5 x 23.8 x 4.75	5.4	0.7	\$274
-----------	-------------------	-----	-----	--------------

Super slim profile accommodates leg clearance requirements of more users. Knobless height adjustment and independent tilt adjustment. Positive tilt lockout available by special order with extended lead time. Height and depth indicators together in dashboard. Compatible with all Global keyboard mechanisms. Good for single users who frequently change positions and for multiple users. Swivels 360°.

- KSFK-21 requires 21.75" of depth clearance under the surface for installation.
- KSFK-18 requires 18" of depth clearance under the surface for installation.
- KSFK-12 requires 12" of depth clearance under the surface for installation.
- *Specify keyboard tray separately, see page 80.*

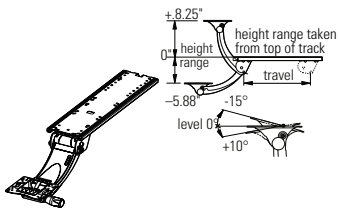



Lift-N-Lock Sit-Stand Mechanism

KSM03-21	9 x 23.8 x 9.7	11.8	0.9	\$428
KSM03-18	7.4 x 19.7 x 8	9.7	0.7	\$428
KSM03-12	5 x 13.1 x 5.3	6.5	0.5	\$428

Ergonomic support for both seated and standing positions. Curved neck allows user closer access to the desk. Positive tilt lockout available by special order with extended lead time. Compatible with all Global keyboard mechanisms. Recommended for single users who alternate between sitting and standing. Swivels 360°.

- KSM03-21 requires 21.75" of depth clearance under the surface for installation.
- KSM03-18 requires 18" of depth clearance under the surface for installation.
- KSM03-12 requires 12" of depth clearance under the surface for installation.
- *Specify keyboard tray separately, see page 80.*

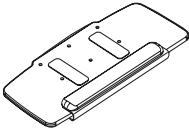
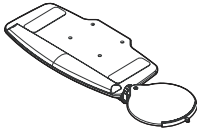
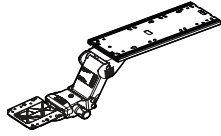
KEYBOARD SUPPORT PACKAGES

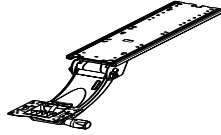
<p>Packages consist of a keyboard tray with mouse support, keyboard mechanism and a 21.75" glide track which requires 21.75" of depth clearance under the surface for installation.</p> <p>Contact Customer Service for 18" and 12" glide track package pricing.</p>	 <p>KT27M02</p>	 <p>KTMT03</p>
 <p>KSM02-21</p>	<p>KP0202 \$529</p>	<p>KP0203 \$550</p>
 <p>KSKF-21</p>	<p>KPSF02 \$529</p>	<p>KPSF03 \$550</p>
 <p>KSM03-21</p>	<p>KP0302 \$691</p>	<p>KP0303 \$712</p>

CPU HOLDERS

MODEL #	DIMENSIONS	WT/LB.	CUBIC FT.	LIST PRICE
	W x D x H			

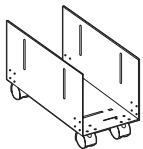

CPU Holder on Casters

PCPU-HC	5.5-9 x 15 x 9.25	8	0.45	\$149
---------	-------------------	---	------	--------------





Adjusts 5.5" - 9." in width. Front locking casters. Assembly hardware included. Height without CPU is 9.25". Depth without CPU is 15". Black only.

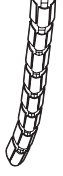

CPU Holder on Glide Track

PCPU-GT	3.5 x 9.3 x 13.5	12.6	1.4	\$281
---------	------------------	------	-----	--------------

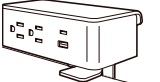
Accepts tower CPUs with widths from 3.5" to 9.3" and heights from 12.5" to 22.5". 17" glide track and 360° swivel for easy access to rear of CPU. Steel and engineered resin construction.

POWER / DATA	MODEL #	DIMENSIONS W x D x H	WT/LB.	CUBIC FT.	LIST PRICE
 <p>Cable Snake</p>	PCSN01	3 x 2 x 31.25	2.1	0.2	\$115
	Flexible cable management. Provides access to power/data from floor to underside of worksurface where it attaches. Two pathways within cable snake. Length under desk is 31.25". Silver plastic only.				
 <p>Cable Snake Extension</p>	PCSN01E	3 x 2 x 18	2.1	0.2	\$92
	Extension kit to use with cable snake PCSN01. Additional 8 links extend cable snake up to 49" in length. Ideal for height adjustable tables. Silver plastic only.				
 <p>DPC Slim Desktop 2 Power/USB-A and -C</p>	PSDPC22W	4.88 x 2.25 x 2.25	2.5	0.5	\$449
	Desktop power center with two 15A tamper resistant power receptacles, one USB-A port and one USB-C port (provides 3.1A). 10' cord with molded plug. Includes three mounting options: a screw-in mounting plate for forward facing outlets; under surface mount bracket; or a clamp mounting kit for 0.5"-1.5" thick surfaces. Gloss White body with Grey face.				
 <p>DPC Slim Desktop 3 Power/USB-A and -C</p>	PSDPC32W	6 x 2.25 x 2.25	2.6	0.5	\$586
	Desktop power center with three 15A tamper resistant power receptacles, one USB-A port and one USB-C port (provides 3.1A). 10' cord with molded plug. Includes three mounting options: a screw-in mounting plate for forward facing outlets; under surface mount bracket; or a clamp mounting kit for 0.5"-1.5" thick surfaces. Gloss White body with Grey face.				
 <p>Clamp Mount 2 Power/USB-A and -C</p>	PS3525057	5.5 x 3.2 x 3	3	0.2	\$695
	PS3525002	5.5 x 3.2 x 3	3	0.2	\$695
Ashley Duo clamp mount module with two 15 amp 120 volt AC receptables; 2.4 amp USB-A port and 60 watt USB-C power delivery port. 10' cord with molded plug. UL listed. Clamp accommodates worksurfaces 0.5" to 1.5" thick; fastened with thumb screws. PS3525057 - White module with Silver bracket. PS3525002 - Black module with Silver bracket.					
 <p>Under Mount 2 Power/USB-A and -C</p>	PS3526057	5.5 x 2.8 x 1.8	3.2	0.2	\$695
	PS3526002	5.5 x 2.8 x 1.8	3.2	0.2	\$695
Ashley Duo under mount module with two 15 amp 120 volt AC receptables; 2.4 amp USB-A port and 60 watt USB-C power delivery port. 10' cord with molded plug. UL listed. Mountable under most worksurfaces. PS3526057 - White module with Silver bracket. PS3526002 - Black module with Silver bracket.					

POWER / DATA	MODEL #	DIMENSIONS	WT/LB.	CUBIC FT.	LIST PRICE
--------------	---------	------------	--------	-----------	------------

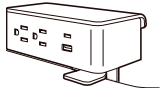

Clamp Mount 2 Power/USB-A and -C

	W x D x H				
PS3525057	5.5 x 3.2 x 3	3	0.2	\$695	
PS3525002	5.5 x 3.2 x 3	3	0.2	\$695	

Ashley Duo clamp mount module with two 15 amp 120 volt AC receptables; 2.4 amp USB-A port and 60 watt USB-C power delivery port. 10' cord with molded plug. UL listed. Clamp accommodates worksurfaces 0.5" to 1.5" thick; fastened with thumb screws.

PS3525057 - White module with Silver bracket. PS3525002 - Black module with Silver bracket.

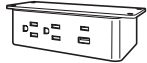

Under Mount 2 Power/USB-A and -C

PS3526057	5.5 x 2.8 x 1.8	3.2	0.2	\$695	
PS3526002	5.5 x 2.8 x 1.8	3.2	0.2	\$695	

Ashley Duo under mount module with two 15 amp 120 volt AC receptables; 2.4 amp USB-A port and 60 watt USB-C power delivery port. 10' cord with molded plug. UL listed. Mountable under most worksurfaces.

PS3526057 - White module with Silver bracket. PS3526002 - Black module with Silver bracket.

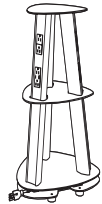

Isle Power Tower

PTISL96GB	18 x 18 x 25.5	28	6.5	\$3760	
PTISL96GW	18 x 18 x 25.5	28	6.5	\$3760	
PTISL96SP	18 x 18 x 25.5	28	6.5	\$3760	

Includes three (3) standard duplexes each with two (2) 110V power outlets; and three (3) USB-A + USB-C duplexes each with two (2) 110V power outlets, one (1) 55W USB-C power delivery port and one (1) 1.5A, 5V USB-A port. Total of twelve (12) 110V power outlets, three (3) USB-A and three (3) USB-C ports. 9' cord with molded plug.

Available in Gloss Black (**GB**), Gloss White (**GW**) and Silver Pearl (**SP**) as indicated by last letter of model number.

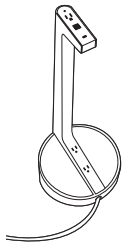

Vesta Portable Power Tower

PPVST3WF	12 x 12 x 28.25	10	4.3	\$2113	
----------	-----------------	----	-----	---------------	--

Includes three 110V power outlets (one on top, two on base), two USB-A and one USB-C charging ports. 10' cord with plug. Matte White finish with Fog inserts.

POWER / DATA **MODEL #** **DIMENSIONS** **WT/LB.** **CUBIC FT.** **LIST PRICE**



Single Sided Recessed Power Block - USB-A + USB-C

	W x D x H					
PRTMCS421B	10.78	x 4.22	x 4.86	4.5	0.51	\$759
PRTMCS421T	10.78	x 4.22	x 4.86	4.5	0.51	\$759
PRTMCS421W	10.78	x 4.22	x 4.86	4.5	0.51	\$759

Single sided recessed power block with **one power/USB-A/USB-C duplex and one data knockout on top; one power duplex on bottom.** USB -A port charges max 2.4 amps at 5V and USB-C port charges max 3 amps at 5V. 10' power cord with straight plug. Specify telecom options separately, see page 86. Available in Black (**B**), Tungsten (**T**) or White (**W**) as indicated by last letter of model number. Duplexes always Grey (duplex with USB ports is glossy finish). Corresponding cut-out options are R1, R2, R3 or RS.

- *Cannot be daisy-chained.*



Double Sided Recessed Power Block - USB-A + USB-C

PRTMCD622B	10.78	x 6.22	x 4.86	6.1	0.51	\$831
PRTMCD622T	10.78	x 6.22	x 4.86	6.1	0.51	\$831
PRTMCD622W	10.78	x 6.22	x 4.86	6.1	0.51	\$831

Double sided recessed power block with **one regular power duplex, one power/USB-A/USB-C duplex and two data knockouts on top; one power duplex on bottom.** USB -A port charges max 2.4 amps at 5V and USB-C port charges max 3 amps at 5V. 10' power cord with straight plug. Specify telecom options separately, see page 86.

Available in Black (**B**), Tungsten (**T**) or White (**W**) as indicated by last letter of model number. Duplexes always Grey (duplex with USB ports is glossy finish). Corresponding cut-out options are T1, T2, T3 or TS.

- *Cannot be daisy-chained.*



Double Sided Recessed Power Block - USB-A + USB-C

PRTMCD642B	10.78	x 6.22	x 4.86	6.3	0.51	\$1001
PRTMCD642T	10.78	x 6.22	x 4.86	6.3	0.51	\$1001
PRTMCD642W	10.78	x 6.22	x 4.86	6.3	0.51	\$1001

Double sided recessed power block with **two power/USB-A/USB-C duplexes and two data knockouts on top; one power duplex on bottom.** USB -A port charges max 2.4 amps at 5V and USB-C port charges max 3 amps at 5V. 10' power cord with straight plug. Specify telecom options separately, see page 86. Available in Black (**B**), Tungsten (**T**) or White (**W**) as indicated by last letter of model number. Duplexes always Grey (duplex with USB ports is glossy finish). Corresponding cut-out options are T1, T2, T3 or TS.

- *Cannot be daisy-chained.*

P PRODUCTIVITY SOLUTIONS™ BY GLOBAL

POWER / DATA

MODEL # DIMENSIONS WT/LB. CUBIC FT. LIST PRICE



Telecom Plate - 2 x 6

W x D x H					
PTELO1	3.25 x 2 x -	0.01	0.05		\$319

Includes 2 x RJ45 cat 6 data jacks. Black telecom plate. To be hardwired by data contractor.



Telecom Plate - 2 x 6

PTEL12	3.25 x 2 x -	1	0.1		\$319
--------	--------------	---	-----	--	--------------

Includes 2 x RJ45 cat 6 data jacks. Grey telecom plate. To be hardwired by data contractor.

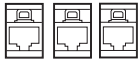

Telecom Plate - 3 x 6

PTELO2	3.25 x 2 x -	0.01	0.05		\$314
--------	--------------	------	------	--	--------------

Includes 1 x RJ11 cat 3 phone jack and 2 x RJ45 cat 6 data jacks. Black telecom plate. To be hardwired by data contractor.



Telecom Plate - 4 x 6

PTELO3	3.25 x 2 x -	0.01	0.05		\$578
--------	--------------	------	------	--	--------------

Includes 4 x RJ45 cat 6 data jacks. Black telecom plate. To be hardwired by data contractor.

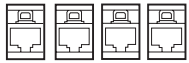

Telecom Plate - 4 x 6

PTEL13	3.25 x 2 x -	0.01	0.03		\$578
--------	--------------	------	------	--	--------------

Includes 4 x RJ45 cat 6 data jacks. Grey telecom plate. To be hardwired by data contractor.

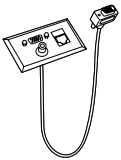

Telecom Plate - 3TSV

PTELO4	3.25 x 2 x -	0.01	0.05		\$400
--------	--------------	------	------	--	--------------

Includes 1 x RJ45 cat 6 data jack, mini stereo and 15 pin HD VGA with female to male connector cable. Black telecom plate. To be hardwired by data contractor.



Telecom Plate - 3SVH

PTELO5	3.25 x 2 x -	0.01	0.05		\$745
--------	--------------	------	------	--	--------------



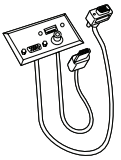

Includes mini stereo, 15 pin HD VGA with female to male connector cable and HDMI with female to female connector cable. Black telecom plate.

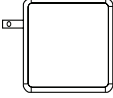

Telecom Plate - 3SVH

PTEL14	3.25 x 2 x -	1	0.1		\$745
--------	--------------	---	-----	--	--------------

Includes mini stereo, 15 pin HD VGA with female to male connector cable and HDMI with female to female connector cable. Grey telecom plate.

POWER / DATA	MODEL #	DIMENSIONS W x D x H	WT/LB.	CUBIC FT.	LIST PRICE
 <p>Telecom Plate - 1 USB-C and 1 USB-A</p>	PTEL08	3.25 x 2 x -	1	0.1	\$277
Includes one USB-C port with 20" male pigtail and one USB-A port with 72" pigtail. Requires powered USB transformer (model PUSBTRSF), to be ordered separately. Grey telecom plate.					
 <p>Powered USB Transformer</p>	PUSBTRSF	3.25 x 2 x -	1	0.03	\$183
Provides power for PTEL08 - 25w, 100-240 VAC, 5-9VDC one USB-C and two USB-A female ports.					
 <p>Telecom Plate - 2 USB-A</p>	PTEL09	3.25 x 2 x -	1	0.1	\$372
Includes two USB-A ports each with 72" patchcord. Grey telecom plate.					
 <p>Telecom Plate - 2 RJ45 and 1 HDMI</p>	PTEL10	3.25 x 2 x -	1	0.1	\$765
Includes two RJ45 Cat 6 data jacks and one HDMI with 36" male pigtail; female/female gender changer. Grey telecom plate.					
 <p>Telecom Plate - 1 HDMI and 1 USB-A</p>	PTEL11	3.25 x 2 x -	1	0.1	\$609
Includes one HDMI female/female with 36" patchcord and one USB-A with 72" patchcord. Grey telecom plate.					

POWER SOLUTIONS FOR FLEXIBLE SPACES

- Perfect for training areas, meeting rooms, in-office workstations and more; Code compliant that allows users to optimize any space providing convenient power access.
- Connect up to four units from a single infeed, delivering AC power and USB charging to the table tops.
- Two styles are available: in-surface modules or on-surface modules.
- Starter modules include 10' corded infeed with 3-prong NEMA plug.
- Touch safe easy to use connectors from module to module with added latch to prevent unintended separation.
- Each module features three tamper-resistant receptacles, USB-A and USB-C charging ports.
- Overall maximum length joined together not to exceed 48.5 feet per infeed.
- UL listed to **UL962A SD**, the standard for furniture power distribution units on portable/movable workspace tables.
- Certified to CSA standard **C22.2 No. 203-16**.
- When ordering in-surface modules be sure to select corresponding cut-out options when specifying tables. Specify **MPS** for a single centered cut-out on the approach side of the table or **MPD** for two cut-outs in the left and right hand positions. Upcharge will apply per cut-out. Cut-outs are available on the following series: **2gether tables, Bungee rectangular fixed and flip-top tables, Bungee SL tables, ConnecTables, Edventure study carrels and Zook rectangular and flip-top tables**. Surface must be a minimum of 1/2" to a maximum of 1 1/2" thick for proper mounting of the units.
- On-surface modules come with a clamp mount that will accommodate any material from 1/2" to 1 1/2" thick; additional brackets are also included for alternate screw in mounting options that can accommodate vertical or horizontal positions.
- In-surface cut-out dimensions: 7.15" x 2.25".

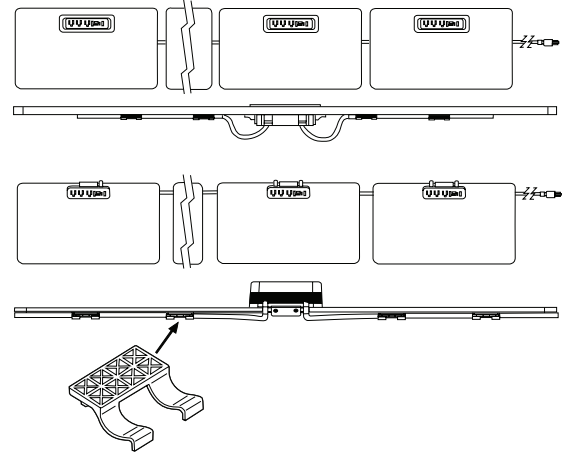

MODPOWER DAISY-CHAIN SOLUTION



ModPower In-Surface Starter Unit



ModPower In-Surface Middle Unit



ModPower In-Surface End Unit

W x D x H

PMDSF10MG	7.63 x 2.75 x 2.63	3.44	1	\$597
PMDSF10WH	7.63 x 2.75 x 2.63	3.44	1	\$597

Includes infeed, one 10' cord with NEMA plug and one 3' connector cord. Unit is equipped with three 15A tamper-resistant receptacles, one USB-A and one USB-C charging ports, and a circuit breaker. Four cable management cord clips included. Specify corresponding cut-out code when ordering table: single centered cut-out (**MPS**) or two cut-outs in left and right positions (**MPD**). Available in Magnesium (**MG**) or White (**WH**) finish as indicated by last characters of model number.

PMDCF3MG	7.63 x 2.75 x 2.63	2.44	2.44	\$562
PMDCF3WH	7.63 x 2.75 x 2.63	2.44	1	\$562

Includes two 3' connector cords. Unit is equipped with three 15A rated 12A tamper-resistant receptacles, one USB-A and one USB-C charging ports, and a circuit breaker. Four cable management cord clips included. Specify corresponding cut-out code when ordering table: single centered cut-out (**MPS**) or two cut-outs in left and right positions (**MPD**). Available in Magnesium (**MG**) or White (**WH**) finish as indicated by last characters of model number.

PMDEF3MG	7.63 x 2.75 x 2.63	1.85	1	\$494
PMDEF3WH	7.63 x 2.75 x 2.63	1.85	1	\$494

Includes one 3' connector cord. Unit is equipped with three 15A rated 12A tamper-resistant receptacles, one USB-A and one USB-C charging ports, and a circuit breaker. Two cable management cord clips included. Specify corresponding cut-out code when ordering table: single centered cut-out (**MPS**) or two cut-outs in left and right positions (**MPD**). Available in Magnesium (**MG**) or White (**WH**) finish as indicated by last characters of model number.

MODPOWER MODULES **MODEL #** **DIMENSIONS** **WT/LB.** **CUBIC FT.** **LIST PRICE**

W x D x H



ModPower On Surface Starter Unit

PMDSA10MG	6.13 x 1.75 x 2.5	4.33	1	\$631
PMDSA10WH	6.13 x 1.75 x 2.5	4.33	1	\$631

Includes infeed, one 10' cord with NEMA plug and one 3' connector cord. Unit is equipped with three 15A tamper-resistant receptables, one USB-A and one USB-C charging ports, and a circuit breaker. Includes edge clamp and three other mounting methods. Four cable management cord clips included. Available in Magnesium (**MG**) or White (**WH**) finish as indicated by last characters of model number.



ModPower On Surface Middle Unit

PMDEA3MG	6.13 x 1.75 x 2.5	3.3	1	\$597
PMDEA3WH	6.13 x 1.75 x 2.5	3.33	1	\$597

Includes two 3' connector cords. Unit is equipped with three 15A rated 12A tamper-resistant receptables, one USB-A and one USB-C charging ports, and a circuit breaker. Includes edge clamp and three other mounting methods. Four cable management cord clips included. Available in Magnesium (**MG**) or White (**WH**) finish as indicated by last characters of model number.



ModPower On Surface End Unit

PMDEA3MG	6.13 x 1.75 x 2.5	2.75	1	\$528
PMDEA3WH	6.13 x 1.75 x 2.5	2.75	1	\$528

Includes one 3' connector cord. Unit is equipped with three 15A rated 12A tamper-resistant receptables, one USB-A and one USB-C charging ports, and a circuit breaker. Includes edge clamp and three other mounting methods. Two cable management cord clips included. Available in Magnesium (**MG**) or White (**WH**) finish as indicated by last characters of model number.

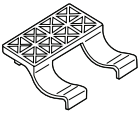

ModPower Cable Management Clips

PMDCLIPS	2.6 x 2.5 x 0.6	0.3	0.2	\$102
----------	-----------------	-----	-----	--------------

Package of 10 clips.



ModPower Interconnecting Jumper

PMDJ36BK	36 x - x -	1.38	0.9	\$329
----------	------------	------	-----	--------------

Interconnection jumper cord to add an additional 3' of cord length between in-surface and on-surface ModPower units. 3' cord with male and female connector. Package of 2 jumpers.

P PRODUCTIVITY SOLUTIONS™ BY GLOBAL

OFFICE ACCESSORIES

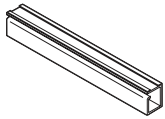

Wire Manager



Vertical Wire Manager

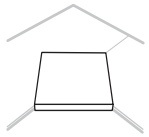

Corner Keyboard Plate*

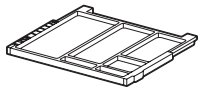

Pencil Drawer

MODEL #	DIMENSIONS W x D x H	WT/LB.	CUBIC FT.	LIST PRICE
PEWM5.5	66 x 2 x 2	0.6	0.1	\$136
PEWM5	60 x 2 x 2	0.6	0.1	\$114
PEWM4.5	54 x 2 x 2	0.5	0.1	\$103
PEWM4	48 x 2 x 2	0.5	0.1	\$89
PEWM3.5	42 x 2 x 2	0.4	0.1	\$80
PEWM3	36 x 2 x 2	0.4	0.1	\$70
PEWM2.5	30 x 2 x 2	0.3	0.1	\$55
PEWM2	24 x 2 x 2	0.3	0.1	\$46
PEWM1.5	18 x 2 x 2	0.2	0.1	\$34
PEWM1	12 x 2 x 2	0.2	0.1	\$25

Plastic tray flexes to receive and hold electrical and data wires. Quickly attaches with two strips of double-sided tape. Black only.

PEVWM	22 x 2 x 2	0.3	0.1	\$46
-------	------------	-----	-----	-------------

From underside of worksurface to bottom panel. Capable of holding electrical and data wires in a vertical position. Black only. Attaches with two strips of double-sided tape.

PEEOCKS	18 x 18 x 1.12	6	0.3	\$79
---------	----------------	---	-----	-------------

Converts two 1" thick worksurfaces at 90° into a keyboard support corner. Finished in Black (**BLK**) or Tungsten (**TUN**) epoxy coating.

PEEPD	22.5 x 15 x 1.5	2	0.7	\$145
-------	-----------------	---	-----	--------------

Black ABS plastic. Provides space for writing instruments and small items at the workspace. Attaches to underside of any 24"D and 30"D worksurface with included roller slides. There are no specifications for Pencil Drawer.

- May be used with all Casegoods.

Required specifications



Finish*

CENTER DRAWERS

NOTES:

- Center drawers must be dealer or end user installed. Drawers do not fill entire center space opening.
- Approximate kneespace widths are:

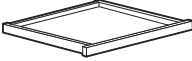
30" x 60" DP	25.5"	30" x 66" DP	31.5"
30" x 72" DP	37.5"	30" x 66"/20" x 40" L	22.5"
30" x 66"/24" x 48" L	24.5"	36" x 72"/24" x 48" L	30.5"

CENTER DRAWERS	MODEL #	DIMENSIONS W x D x H	WT/LB.	CUBIC FT.	LIST PRICE
 <p>Center Drawer*</p>	CD28	28 x 18 x 3	5	1	\$248
Laminate drawer front is attached to a 4-sided frame. Recommended for use on 36" x 72" desks. Specify finish from list available in each series.					
 <p>Flat Bracket</p>	M393	4.5 x 3.12 x 0.25	1	1	\$16
Used as a mending plate to give additional worksurface support.					

Required specifications
Finish*

QUICK ASSEMBLY ELECTRIC HEIGHT ADJUSTABLE BASE

GENERAL INFORMATION

- Quick assembly electric height adjustable bases with leg columns preassembled to telescopic cross bar assembly including electric motors. Unfold leg columns, attach feet and worksurface support to base; fasten assembly to top; plug in connections and start to use.
- 3-stage base. Range of adjustability with 1" thick top is 22.6" to 48.2"H.
- Easy to use up-down controller with digital read-out and four memory programmable positions.
- Dual motor with 265 lbs. lift capacity.
- Anti-collision sensor.
- Standby power consumption 0.1W. Active power consumption 220W.
- Operates at 1.2" per second.
- 8' long power cord.
- Meets applicable ANSI/BIFMA x5.5 standards.
- ETL/CETL and Greenguard Certified

ELECTRIC HAT COMPONENTS	MODEL #	DIMENSIONS	WT/LB.	CUBIC FT.	LIST PRICE
--------------------------------	----------------	-------------------	---------------	------------------	-------------------



Quick Assembly Electric HAT - 3-Stage, 2-Leg Base Only

W x D x H					
MLIR30B	42.5 x 22.8 x 21.6-47.2	77.2	2.9	\$1049	

Quick assembly 2-leg, 3-stage electric height adjustable table base. Beam and leg columns with motors are preassembled. Unfold leg columns and lock into place. Width adjustable for 46"W to 76"W tops. Specify base finish: Black (BLK) or Tungsten (TUN). Shipped partially assembled in 1 carton.

Base can be used with all FreeFit surfaces of 23"D and 29"D, from 46"W to 70"W.

MOBILE PEDESTALS



Box/File Mobile Pedestal

MODEL #	DIMENSIONS W x D x H	WT/LB.	CUBIC FT.	LIST PRICE
NLMP23BF	16 x 22.7 x 22.1	74	6.5	\$774

Mobile pedestal with one box and one file drawer. Front lock - both drawers locking. File drawer accommodates front-to-back letter size or side-to-side legal size hanging files. Pedestal top features 1" overhang with built-in grip for ease of mobility. Includes counterweight to prevent tipping. Pencil tray included. Front locking casters. Shipped assembled in 1 carton.



Box/Box/File Mobile Pedestal

NLMP23BBF	16 x 22.7 x 28	93	8.25	\$925
-----------	----------------	----	------	--------------

Mobile pedestal with two box drawers and one file drawer. Front lock - all drawers locking. File drawer accommodates front-to-back letter size or side-to-side legal size files. Pedestal top features 1" overhang with built-in grip for ease of mobility. Includes counterweight to prevent tipping. Front locking casters. Pencil tray included. Sits flush with user edge under 30"D table desks with or without modesty panel or 24"D returns without modesty panel. Does not sit flush under 24"D table desk. Shipped assembled in 1 carton.

PEDESTALS



Hanging Box/File Pedestal

NL23HBF	16 x 23 x 18	54	5.25	\$517
---------	--------------	----	------	--------------

One box drawer and one file drawer. Front lock - both drawers locking. Non-handed, open back. Pencil tray included. For use with bow or rectangular desks, returns or credenzas with laminate side gables and full modesty panel. Top is open. File drawer accommodates front-to-back letter size or side-to-side legal size files. Shipped assembled in 1 carton.

OTG ACCESSORIES



Desktop Short Partition

MLDTP3224	31.5 x 15.5 x 23.5	7	0.5	\$256
-----------	--------------------	---	-----	--------------

Lightweight freestanding desktop partition. Move wherever you need to provide a focus space. 9mm thick PET Felt, no hardware connections. Folds flat for storage when not in use. Ships in two pieces with a puzzle-like joint. Easy to assemble.

finishes

Care and Cleaning

Hard Surfaces

Laminate, painted +plated metal finishes: Wipe the surface with a clean soft damp cloth; if needed, a mild soap solution (i.e. Ivory dishwashing liquid) can be used. To prevent streaks, dry the surface with a clean dry soft cloth moving in a circular motion.



Desks, Workstations, Tables and Accessories - Laminate

Absolute Acajou (ACJ)	Asian Night (ASN)	Avant Cherry (AWC)	Avant Honey (AWH)	Black (BLK)	Blizzard (BZD)
Brushed Cobalt (BRC)	Clear Maple (CMB)	Custom Grey (CGY)	Dark Espresso (DES)	Designer White (DWT)	Fashionista (FAS)
First Class (FCL)	Noce Biondo (NBL)	Noce Grigio (NGL)	Noce Leggero (NEL)	Noce Medio (NML)	Quartered Mahogany (QTM)
Sheer Beauty (SBY)	Stonedust SDT	Storm Grey (SOG)	Walnut Heights (WHE)	White Chocolate (WHC)	Winter Cherry (WCR) *

Solid Wood and Laminate Coordinating Colors

Solid Wood Colors

Absolute (AAM)
 Black (BKM)
 Cherry (ACM)
 Espresso Cafe (ECM)
 Fruitwood (TFM)
 Gray (HGM)
 Honey (AHM)
 Mahogany (TMM)
 Maple (AVM)
 Medium Walnut (MWM)
 Night (ASM)
 Noce Biondo (NBM)
 Noce Grigio (NGM)
 Noce Leggero (NEM)
 Noce Medio (NMM)
 Walnut (TWM)
 WC Cream (WTM)
 White (WHM)
 Winter Cherry (WCM)

Laminate Colors

Absolute Acajou (ACJ)
 Black (BLK)
 Avant Cherry (AWC)
 Dark Espresso (DES)
 -
 -
 Avant Honey (AWH)
 Quartered Mahogany (QTM)
 Clear Maple (CMB)
 -
 Asian Night (ASN)
 Noce Biondo (NBL)
 Noce Grigio (NGL)
 Noce Leggero (NEL)
 Noce Medio (NML)
 -
 White Chocolate (WHC)
 Designer White (DWT)
 Winter Cherry (WCR)

Metal Leg Finishes *(check series for applicable finishes)*

Antique Copper (ACO)	Black (TBL)	Brushed Chrome (BCH)	Buzz Blue (TBZ)	Cactus (TCC)	Carrot (TCR)
Cloud (TIV)	Chrome (CHM)	Designer White (TDW)	Dijon (TDJ)	Eggplant (TEG)	Fog (TFO)
Frost (TFR)	Ink (TIN)	Kalua (TKA)	Latte (TLA)	Mocha (TMO)	Nevada (TNE)
Sand (TSN)	Satin Brass (SBR)	Scarlet (TSR)	Shadow (TSH)	Toast (TOA)	Tungsten (TTU)

LAMINATE FINISH CHART

FINISH CODE	ACJ	ASN	AWC	AWH	BLK	BZD	BRC	CMB	CGY	DES	DWT	FAS	FCL	NBL	NGL	NEL	NML	QTM	SBY	SDT	SOG	WHE	WHC	WCR	
LAMINATE DESKING																									
TABLES - CAFÉ, MEETING & CONFERENCE																									
Swap	•	•	•	•	•	•	•	•	•	•	•	•	•	•	•	•	•	•	•	•	•	•	•	•	•
Zira boardroom	•	•	•	•	•	•	•	•	•	•	•	•	•	•	•	•	•	•	•	•	•	•	•	•	•
TABLES - TRAINING																									
Bungee	•	•	•	•	•	•	•	•	•	•	•	•	•	•	•	•	•	•	•	•	•	•	•	•	•
Junction	•	•	•	•	•	•	•	•	•	•	•	•	•	•	•	•	•	•	•	•	•	•	•	•	•
TABLES - RECEPTION & OCCASIONAL																									
Citi	•	•	•	•	•	•	•	•	•	•	•	•	•	•	•	•	•	•	•	•	•	•	•	•	•
Occasional Tables	•	•	•	•	•	•	•	•	•	•	•	•	•	•	•	•	•	•	•	•	•	•	•	•	•
Sirena Tables	•	•	•	•	•	•		•	•	•	•	•	•	•	•	•	•	•	•	•		•	•	•	•
Wind Tables	•	•	•	•	•	•	•	•	•	•	•	•	•	•	•	•	•	•	•	•	•	•	•	•	•
PRODUCTIVITY SOLUTIONS																									
Height Adjustable Tables	•	•	•	•	•	•	•	•	•	•	•	•	•	•	•	•	•	•	•	•	•	•	•	•	•

This illustrated list price book has been designed to facilitate fast reference and easy use. Products are categorized into “seating”, “desks”, “files”, “panels” or “tables” and are listed numerically within their categories. The line drawings match actual photographs (where possible) to aid in instant recognition of the total range within a series.

Sales of Global Furniture Group (“Global”) products are made only on Global’s standard Terms and Conditions of sale which are contained in this list price book. The “Purchaser” in these Terms and Conditions shall refer to Dealers and those who originally purchase directly from Global for use or re-sale. These standard Terms and Conditions may be modified or supplemented only by a separately written document signed by Global’s authorized personnel at its head office in Toronto, Ontario, Canada. Any term or condition contained in any purchase order or other form used by the Purchaser to order goods (including standard, printed language) which is different from, in addition to, or in any way inconsistent with Global’s standard Terms and Conditions shall be of no force or effect whatsoever.

All illustrations, specifications and prices in this list price book are based on the latest product information available at time of publication. Global reserves the right to make changes at any time and without prior notice to prices, colors, materials, specifications and models offered.

Description

Each product shown or described in this list price book is standard Global product. Available options are noted at the beginning of each series. Available options may require additional delivery time and cost, and may affect the warranty given. Sizes and weights shown are approximate and are subject to slight changes from time to time.

Prices and Payment

The prices shown in this list price book as well as those quoted by Global, are in Canadian dollars for orders shipped to destinations in Canada.

If shipping date requested is more than 90 days from date of order, Global shall reserve the right to use published list prices effective at time of shipment.

Orders are invoiced at time of shipment. Terms of payment are net 30 days from date of invoice unless otherwise stated. The Purchaser agrees that Global shall reserve the right to enforce a charge amounting to 1.5% per month (18% per year) on invoices outstanding more than 30 days.

If the Purchaser’s most recent annual net volume is less than \$5,000, Global may suggest payment be made in advance.

All orders are subject to the Purchaser complying with Global’s prevailing credit policy.

Any products sold by Global shall remain the property of Global until fully paid.

Prices are suggested list prices only and are subject to change without notice. Global will, however, attempt to keep the Purchasers up-to-date on all developments including price changes.

Taxes

All prices shown in this list price book are exclusive of sales, use, excise, HST and other applicable taxes and duties which may be the Purchaser’s responsibility as per the invoice issued by Global. If the Purchaser claims an exemption from such taxes, it shall be the Purchaser’s responsibility to furnish Global with an appropriate exemption certificate at time of order.

Ordering Information

Global requires that all orders be submitted in writing and will be acknowledged on Global’s acknowledgement forms governing the transaction.

The details appearing on this acknowledgement will describe the items to be shipped and the approximate shipping date. It is the Purchaser’s responsibility to determine that the information in the acknowledgment is correct. In the event of an error, the Purchaser must notify their Global Customer Service representative immediately by telephone followed by written confirmation. Shipping dates are assigned to orders based on the items having the longest manufacturing lead time (unless instructed to partial ship).

At time of order, please provide the following information:

1. Account number (if possible)
2. PO number
3. “Bill to” and/or “Ship to” and name and address
4. Complete model number and selected options including textiles/finishes
5. Special instructions and tag information
6. Shipping instructions, please indicate:
 - a. pick up
 - b. Global trailer program
 - c. common carrier, provide name of carrier, your account number
7. Special quote (SQ) # or MTM # (if applicable)
8. Customer’s Own Material (COM), Global Purchased Material (GPM), Customer’s Own Leather (COL), see below.
9. For specials and custom quoted product, please indicate the custom quote # on your PO. If changes are made to the quote a new quote must be issued prior to submitting the order. It is the Purchaser’s responsibility to determine that the information on the quote is correct. Global will not be responsible for wrong product due to errors in the quote.

The above points will be checked by Global for accuracy. Global will process orders using the codes provided by the Purchaser. Price discrepancy is the responsibility of the Purchaser. The Purchaser must notify Global prior to invoicing.

The Purchaser is responsible for providing correct information at time of order. If no option(s) are selected the system will default to standard feature(s). Orders with missing/incorrect information (finish, etc.) will be put on hold until all information is complete. Orders will be scheduled for manufacturing upon receipt of complete information.

Changes and Cancellations

After the date of Global’s acknowledgment of the Purchaser’s order, the order may not be changed or cancelled by the Purchaser without the written consent of Global. Orders for products upholstered in “special order textiles” (GPM) cannot be cancelled once material has been purchased. Special order items, COM and textile-covered items already in production are not subject to change or cancellation under any circumstances. Textile-covered items are considered to be in production once the textile is scheduled for cutting. Other standard items already in production are subject to a minimum 35% cancellation charge.

Errors and Omissions

All quotations, acknowledgements and invoices are subject to corrections for any errors and omissions.

Casters

The list price book specifies the caster which comes standard with each chair model. Most chairs are equipped with C1 or C65 casters which are best used on carpeted surfaces. If it is intended to use the product on hard surfaces such as ceramics, concrete, linoleum or hardwood, it is recommended to use different casters. It is the responsibility of the customer to determine the standard caster for a particular product and whether such caster is appropriate for the given application. The Arm and Caster section illustrates the caster options offered by Global and their suggested uses.

FINISHES

Seating Finishes - Painted

Where painted frames are not a standard color, a special quote is required.

Seating Finishes - Wood Stains

A one time setup fee of \$250 net will be applied per order for custom wood staining/color matching requests. This payment will be valid for 5 years from the date it is set up. After 5 years, the \$250 setup fee will apply again. Restrictions may apply. The customer must provide a 3” x 3” color chip/sample.

For application of customer’s own wood stain, there will be an upcharge of 10% list price, per unit (in addition to the option upcharge, when applicable). For orders with custom stain unit quantities of 30 or more, the upcharge may be reduced or eliminated. A [Special Product Request](#) must be submitted for a quotation.

Custom Wood Staining

Custom wood staining procedure for wood seating is as follows. Customer provides a sample of the desired wood finish. That sample is sent to Specials department. Several finished samples will be sent back. The customer/end user will sign off on the samples (keeping one for their records) and return the rest of the samples. Global will not necessarily match the wood species but rather will generate a color that will coordinate with the sample when it is applied to the wood species used in the seating frame.

File Finishes

There is no upcharge on any standard file finish. Any non-standard file finish must be approved by Global prior to acceptance of order and may be subject to an upcharge.

9300 Series, 9300 Plus Series and G Series Pedestals can be ordered in non-standard finishes with a 10% upcharge on orders up to and including 10 units. There is no upcharge on orders of 11 units or more.

Please note:

- You can only combine 9300 Series and 9300 Plus Series to meet the 11 unit minimum.

An upcharge of 10% will apply to Metallic, Mica, Tungsten and any non-standard White finishes regardless of the number of units ordered.

Wood Veneer Finishes

Because the distinctive characteristics and the nature of wood products cause variations, exact matches are not always possible. Global will not be held responsible if the finishes cannot be matched.

Customer's Own Material (COM)

Use of COM must be approved by Global prior to acceptance of order. Please submit the Authorization Request Form. Photocopy and use this form as often as necessary. The customer must provide a 12" x 12" textile sample and advise how the textile is to be applied and quantity of textile being sent. **Textile yardage requirement will be advised by the factory, and additional yardage may be required if pattern requires matching.** Upon approval from Global, send textile to the COM Department at: 596 Supertest Road, Toronto ON, M3J 2M5. Send to the address provided on shipping document upon approval from Global. If COM is difficult to apply or if product is required to be modified, extra charges will apply. Global reserves the right to cancel an order at any time if COM is inadequate for any reason. COM must be shipped freight and duties paid if applicable to our factory. Such shipment must be fully identified with the Purchaser's order number, and the item for which the material is intended. Performance of COM when applied to product is the sole responsibility of the Purchaser. Global's standard product warranty shall not apply to COM.

COM price is the lowest published price/grade for the series. The published yardage requirement for COM orders is approximate and shown beside each item in the list price book. The yardage shown there is based on the textile requirements for cutting and sewing a single chair in a plain patterned textile. For textiles with a pattern repeat or for COM orders involving 10 or more chairs, please consult with Customer Service for recalculation of the yardage requirements as this may significantly change the textile requirement.

Textile Grading

All products are priced according to their standard textile grade. Lower grade textiles may be available but at the same price as standard textile grade. See Textiles and Finishes section for graded textiles.

Combining two grades of textiles may result in a revised grade. Please refer to "Two Grades Combination Chart" in the Textiles and Finishes section. For more than two textiles a special quotation is required.

Global Purchased Material, Customer Specified (GPM)

Global may purchase material specified by the customer. Use of GPM must be approved by Global prior to acceptance of order. If it is difficult to apply or if product is required to be modified, extra charges will apply. Global reserves the right to cancel an order at any time if GPM is inadequate for any reason. Performance of GPM when applied to product is the sole responsibility of the textile vendor. Global's standard warranty will not apply to GPM materials.

Customer's Own Leather (COL)

Not all seating can be upholstered in leather. Please consult service notes for availability. COL price is the lowest published grade for the series (leather or fabric).

Upholstery Coverings

Slight variations in color may occur between dye lots. Although Global attempts to minimize these variances, they do occur and must be accepted as normal and will not be considered defects.

Leather is a Natural Product

Natural variations occur in the color, grain and texture of leather. As a result, a degree of variation should be expected. As leather is used it develops a patina. Its color changes slightly, it will get marked and it will stretch and pull, these are the hallmarks of genuine leather and are not considered defects.

Yardage

Required yardage (yd) is based on unmatched materials with widths of 54" for seating, 63" for panels.

Arms

A wide selection of arms are available for some series. See Arm Chart in the Seating list price book.

Weight

In the Seating list price book, weight is provided for both unit weight and carton weight. In the Desking + Tables and Metal Filing + Storage list price books, carton weight is provided.

Delays

Global's order acknowledgment will state a shipping date which is Global's best estimate at the time the order is acknowledged. However, Global shall not incur any obligation or liability to the Purchaser for failure to ship by specified date unless Global has agreed to an unequivocal shipping date in a separately signed written document executed by its authorized personnel at its head office. In addition, Global will not be liable for any loss or damage resulting from any delay or failure in shipment or other failure to perform all or any part of the agreement between the parties with respect to the goods shown on the face of the order acknowledgement where such delay, failure, loss or damage is the proximate result of any act of any governmental authority or political subdivision thereof, revolution, riot, civil disorder or disturbance, delay or default in transportation, strike disputes among or between labor unions or other labor disputes, delay or inability in obtaining materials and facilities, fire, flood, act of God or any cause not within the reasonable control of Global.

Free on Board (FOB)

FOB point is Global's Factory, Toronto, Ontario, Canada.

Courier Type Shipments

This symbol is used to indicate that the adjacent product can be sent by courier type shipments, such as Federal Express, Purolator, CanPar and UPS.

Shipping

The Purchaser must select, at time of order, one of two methods of freight payment. Global will make no end-user shipments unless special arrangements have been made.

1. FOB point of shipment, freight collect - pick up and common carrier.
2. FOB point of shipment, freight prepaid and invoiced to the Purchaser - Global Trailer Program.

All deliveries are dock to dock.

Service

Service requests are normally the responsibility of Global's authorized Dealers. Where this cannot be accomplished on a local level, service problems should be referred to Global's Customer Service Department.

Global/Express (Canada)
Tel: (905) 660-5101 or 1-800-567-8901
Fax: (905) 660-4759 or 1-800-375-5134

Global International
Tel: (416) 661-3660
Fax: (416) 661-661-0983 or 1-877-585-5579

Returns

No returns of goods will be accepted without written consent and shipping instruction from Global. A minimum re-stocking charge of 35% is made on all authorized returns for credit or refund, provided goods are received by Global in the condition in which they left the factory. This may increase depending on the type of product. Global's Return Goods Authorization (RGA) numbers must appear prominently on all authorized returns. Global will not be responsible

for return freight costs. No credit will be given if goods cannot be reused as new. Special order items, non-stock items and COM products are in no event subject to return. All returns must be approved and authorized in writing by Global Customer Service. Global reserves the right to refuse delivery of any unauthorized returns.

Claims

All goods are sold FOB plant or Global Distribution Center. Global is not responsible for damage which occurs in transit (or in storage). The carrier signs for all goods received in apparently good order. It is the Purchaser's responsibility to examine goods upon receipt and to file any claims with the carrier for losses or damage to the product occurring during transit, including concealed damage.

Any claims made against Global for apparent defects, errors or shortages must be made by the Purchaser, in writing, within 15 working days after any delivery. Failure by the Purchaser to make any claim against Global within 15 days shall constitute acceptance of the goods and a waiver of any apparent defects, errors or shortages.

Suspension

In the event that the Purchaser defaults in the payment of any sum due to Global, or in the event the Purchaser's financial condition becomes unsatisfactory to Global, Global shall have the right to defer or discontinue shipment of any goods until such time as the default is cured or the Purchaser provides assurance of payment to Global.

Copyright

All catalogs, photographs, drawings, list price books and other printed materials are protected by copyright. All rights reserved.

Trademarks

All trademarks are owned by Global Furniture Group other than OBUSFORME™ which is owned by OBUSFORME LTD CO., a division of Homematics Inc., MOR-CARE which is owned by MORBERN INC, Perma-Mesh which is the property of J.B. Research Inc. SCHUKRA™ which is owned by SCHUKRA MANUFACTURING INC. OBUSFORME® and the distinctive backrest design are registered trademarks of OBUSFORME LTD CO.

Designs and Patents

Many of the products produced by Global are protected by design registrations, design patents and/or patents. Design and specifications are subject to change, discontinuance or additions without notice.

For a full listing of issued trademarks, please visit globalfurnituregroup.com.

Cubic Measure

The stated volume is an approximate cubic foot measure that may be used to calculate freight costs. The figure shown is the total shipping volume of a unit (e.g. if a part is sent in 2 cartons the volume indicated reflects both cartons together) and is subject to change without notice. It is most economical to purchase the specified number per carton.

Combined Shipments

Global will make every effort to combine shipments and orders on written request. However, Global cannot be held responsible where such requests are not complied with.

Offer of Sale

Possession of this list price book or any other literature shall not imply the company's willingness to sell to the holder and shall not be construed as a direct offer of sale.

If a conflict arises between: (i) prices found in software support packages furnished to the customer by Global or by any other source on behalf of Global; and (ii) Global's current pricing found on Global's website, then the most current shall prevail.

Testing Qualifications

Many Global products pass or exceed the most stringent industry testing standards.

Disclaimer

Metric dimensions are provided for seating products for reference only. In the event that there is a discrepancy between imperial measurements and metric measurements, imperial measurements shall prevail. Prices shown are current manufacturer's suggested list prices at time of printing. Updated pricing is available on Global's website. All applicable taxes are extra. Descriptions, specifications and prices are subject to change without notice. Errors and omissions are subject to correction.

Fire Codes

Flame resistant components are most often requested to be tested to comply with California Technical Bulletin 11, often referred to as CAL117. The foam used in Global chairs meets the requirements of California TB117 and all of the upholstery fabrics Global offers meet this requirement. In addition, most Global seating models can be certified to California TB133. This available certification can be done when selected seating models are upholstered in specific textiles. The list of certifiable seating models and available textiles changes from time to time. Please contact Customer Service for a list of certifiable models and upholstery materials. There are other fire codes that are not commonly specified. Global Upholstery Ltd. can usually provide test results for any North American code. Please contact Customer Service. Please see chart below for CAL TB 133 upcharges and for complete CAL TB 133 information refer to the Global Dealer Centre.

**WARNING - SEATING PRODUCTS
TO PREVENT PRODUCT FAILURE AND POSSIBLE INJURY:**

Ensure that the appropriate selection is made for the intended use of the chair including user's weight. Some chairs are not recommended for users above a certain weight. Frequently inspect the chair for visible cracks and tighten all screws, bolts and adjustable knobs. If the chair is damaged or unstable, immediately remove it from service.

Any information or suggestions concerning applications, specifications or compliances with codes and standards is provided solely for your convenient reference and without any representation as to accuracy or suitability. Global disclaims any legal responsibility. The user must verify and test the suitability of any information or products for his specific application. Global reserves the right to change the Terms and Conditions in the list price book without notice.

This list price book is effective as of January 1, 2025.

For periodic updates, please check the PDF at globalfurnituregroup.com. After login, select Resources then Price Lists. From here you will have the option to select either the Seating, Desking + Tables or Metal Filing + Storage price list books. Global warrants that all commercial products are free from defects in material and workmanship, for the life of the product, to the original Purchaser.

Global warrants that all commercial products are free from defects in material and workmanship, for the life of the product, to the original Purchaser.

Global will repair or replace, at Global's option, as the sole remedy for any defect covered by the warranty. The warranty applies to products manufactured after March 22, 2016.

Global makes no warranty that any of its products are suitable for any particular purpose and makes no other warranties, express or implied, other than those set out here. As codes and standards vary from one jurisdiction to another, references to compliance are solely for convenience and without any representation as to accuracy or suitability. Users must verify the suitability of such information or product for their specific application. In no event shall Global be liable in either tort or contract for any loss or direct, special, incidental, consequential, or exemplary damages.

Files, Desks, Modular Furniture, Tables, Panels & Accessories

Global warrants all components of metal storage and filing, laminate and wood veneer desks, laminate and wood veneer tables, metal leg components and panels for the lifetime of the product to the original Purchaser.

The warranty applies to single shift, standard commercial usage, defined as a standard eight (8) hour day, forty (40) hour week. Load restrictions apply, refer to individual product descriptions.

Exceptions to the warranty for files/desks/tables and panels are as follows:

- Electrical devices, moving parts, panel and tackboard textiles, adjustable keyboard mechanisms, non-electrical table mechanisms, monitor arms, coat trees and task lights - five (5) years
- Writable surfaces and whiteboards - three (3) years
- Keyless lock options - two (2) years
- Battery pack - one (1) year

Files, Desks, Modular Furniture, Tables, Panels & Accessories Warranty Summary

Product Type	Components Warranty For Original Purchaser	Exceptions
Metal storage and filing	lifetime	2 years - keyless lock options
Laminate/wood veneer desks and modular furniture	lifetime	5 years - tackboard textiles, electrical devices, task lights
Boardroom, conference and training tables and general tables	lifetime	5 years - electrical devices, moving parts
Electric height adjustable bases	7 years	1 year - battery pack
Non-electric height adjustable bases	5 years	
Productivity Solutions and accessories (adjustable keyboard mechanisms, monitor arms, coat trees, writable surfaces/whiteboards)	5 years	3 years - writable surfaces, whiteboards
Panels	lifetime	5 years - panel and tackboard textiles, electrical devices, task lights

Global's warranty does not apply (for any product category) to the following:

- Nominal or normal amount of wear and tear that can occur over time
- Failures which result from negligence, abuse, accident or misuse
- Failure to apply, install or maintain products according to Global's written instructions and warnings
- Modifications, attachments or repair methods not approved by Global
- Damage caused by a carrier in transit, or delivery/installation contractors
- The matching of colors, grains or textures (wood, leather, etc.) of natural materials
- Products exposed to extreme hot or cold temperatures or excessively dry or humid environments
- Color fastness or the matching of color of textiles, dye lots of textile can vary
- Damage by markings or staining; damage by sharp objects or imprinting from instruments
- Damage to textiles or laminate and wood surfaces/edges from exposure to sunlight (including UV rays)
- Products not purchased directly from authorized Global resellers
- Products used for rental purposes
- Purchased parts are warranted for one (1) year
- Failure to follow specific cleaning and disinfecting instructions posted on globalfurnituregroup.com

Global's warranty does not cover the costs of transportation or labor. Repair or replacement will be at Global's discretion.

Textiles and Finishes

Global textiles and finishes are updated periodically to meet the demand and trends of the market. As a result, some textiles and finishes may be discontinued by Global or the manufacturer. In the event that a textile or finish is discontinued, Global will make every reasonable effort to provide an alternative product(s) of comparable function.

Global offices in Canada

Head Office

560 Supertest Road
Toronto, Ontario
M3J 2M6
T (416) 650-6500

Toronto Sales Office

1350 Flint Road
Toronto, Ontario
M3J 2J7
T (416) 661-3660

Showrooms

Calgary

237 8 Avenue SE, Suite 302
Calgary, Alberta
T2G 5C3
T (403) 250-7770

The Blueprint Montreal

1010 Sainte-Catherine Street W, Mezz 2
Montreal, Quebec
H3B 1E7
T (514) 866-4331

Ottawa

251 Laurier Avenue West, Suite 400
Ottawa, Ontario
K1P 5J6
T (613) 234-2881
Please call ahead to book an appointment.

Edmonton

10158 103 Street NW, Suite 201
Edmonton, Alberta
T5J 0X6
T (780) 444-8922

Toronto

1350 Flint Road
Toronto, Ontario
M3J 2J7
T (416) 661-3660

Vancouver

675 West Hastings Street, Suite 1000
Vancouver, British Columbia
V6B 1N2
T (604) 432-1701

Halifax

1061 Marginal Road, Suite 120
Halifax, Nova Scotia
B3H 4P7
T (902) 422-7434

The Blueprint Toronto

(MetroCentre)
200 Wellington Street West, Suite 1602
Toronto, Ontario
M5V 3C7

Winnipeg

111 Lombard Avenue, Suite 220
Winnipeg, Manitoba
R3B 0T4
T (204) 925-3350

